

ALINCO

VHF/UHF TWIN BAND FM HAND HELD TRANSCEIVER

DJ-G5T/E

Instruction Manual

Thank you for buying this **ALINCO** transceiver. This instruction manual contains important safety and operating instructions. Please read it carefully before using the transceiver.

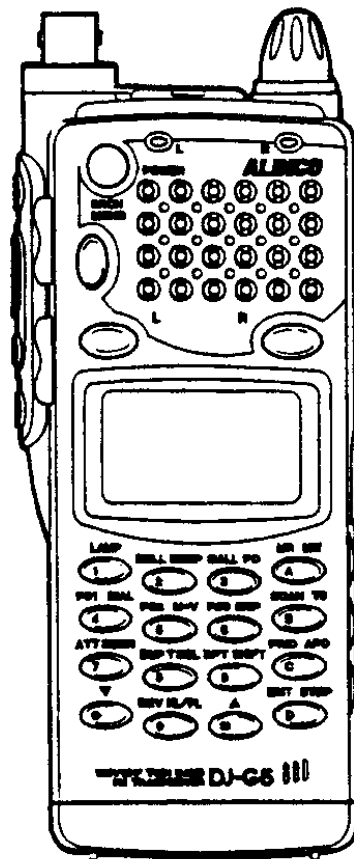

N O T I C E

This equipment has been tested and found to comply with the limits pursuant to Part 15 of the FCC Rules. These limits are designed to provide reasonable protection against harmful interference in a residential installation. This equipment generates, uses, and can radiate radio frequency energy, and if not installed and used in accordance with the instructions, may cause harmful interference to radio communications. However, there is no guarantee that interference will not occur in a particular installation. If this equipment does cause harmful interference to radio or television reception, which can be determined by turning the equipment off and on, the user is encouraged to try to correct the interference by one or more of the following measures.

- *Reorient or relocate the receiving antenna.*
- *Increase the separation between the equipment and receiver.*
- *Connect the equipment into an outlet on a circuit different from that which the receiver is connected.*
- *Consult the dealer or an experienced radio/TV technician for help.*

Table of Contents

① Before Operating the Transceiver

Accessories.....	1
Glossary of Terms	3
Specifications.....	4

② Part Names and their Function

Top.....	5
Front.....	5
Sides	6
Rear	6
Keyboard	7
Display.....	9

③ Basic Operation

1. Turning the power on and Adjusting Volume and Squelch.....	10
Turning the Power on	10
Adjusting the Squelch	11
2. Setting the Main Band	12
Switching the Main Band	12
Mono Band Operation	12
3. The Three Operating Modes ...	13
4. Setting the Frequency in VFO Mode	14
Setting the VFO Frequency ...	14
5. Receiving	16
6. Transmitting	17
Transmitting on the Main Band	17
Transmitting Using the PTT2 Key	18
(Low Power, Tone Burst, and Sub Transmission)	

④ Memory Channels and Call Channel

1. Memory Channels.....	19
Calling Up a Memory Channel	20
Programming a Memory Channel (VFO Mode).....	21
Programming a Memory Channel (Memory Mode)	22
Clearing a Memory Channel ...	22
Transferring a Memory to VFO (Memory Shift).....	23
Setting the Number of Memory Channels.....	23
2. Call Channels	24
Calling Up a Call Channel.....	24
Changing the Call Channel's Frequency	24

⑤ Using the Functions

1. Scans.....	25
Setting Scan Resume Conditions	25
Band Scan	26
Programmed Scan	26
Memory Scan	27
2. Channel Scope	29
VFO Channel Scope	30
Memory Channel Scope	31
3. Sweep Scan	34
Band Sweep Scan	34
Programmed Sweep Scan	35
Memory Sweep Scan	35
4. Priority Watch	37
VFO, Memory and Call Priority Watch	37

5. Repeater	39
Reverse (Receiving on the Transmit Frequency)	40
6. Twin-Band Reception	41
Simultaneous Reception on the Same Band	41
Full Duplex Operation	41
7. Other Functions	42
Shift and Split	42
Turning the Beep On and Off ..	43
Turning the Bell Function On and Off	44
Turning On the Display Light ..	44
Switching the Attenuator On and Off	45
Setting the Tuning Step	45
Keylock	46
Auto Power Off	46
Battery Save	47
Sub Band Mute	47
8. DJ-G5T Functions	48
Cross Band Repeater	48
AM Mode	48

⑥ Communicating with a Specific Partner

Outline	49
1. Tone Squelch	50
2. DSQ	51
Setting DSQ Mode and Codes	51
Communicating Using Code Squelch Mode	53
Communicating Using Group Pager Mode	53
Communicating Using Private Pager Mode	54
Setting the DTMF Transmission Delay Time	55
Outputting DTMF Codes Manually	55

3. Auto Dialer	56
Programming Dial Codes	56
Modifying Programmed Dial Codes	57
Sending Codes Using the Auto Dialer	57

⑦ Maintenance and Reference

Troubleshooting	58
After Service	59
Resetting	60
Packet Operation	61
Cloning Over the Air	62
Options	63
Charger EDC-63/64	64
Ni-Cd Battery	64
Attention	66

1. Before Operating the Transceiver

1

● Accessories

Open the box and check that the following items are present.

- Antenna 1
- Ni-Cd battery pack 1
- Belt clip (two screws)..... 1
- Tricle battery charger 1
- Hand strap 1
- Instruction manual 1
- Quick reference 1

Connecting the Antenna

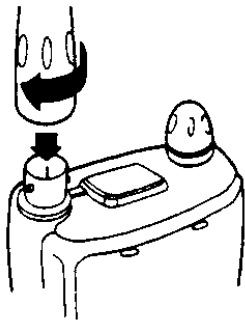

Hold the antenna by its base, and align the grooves in the connector at the base of the antenna with the protruding guides on the transceiver's antenna connector. Slide the antenna down and turn it clockwise to lock it into place.

Turn the antenna counter-clockwise to release it.

Attaching the Belt Clip

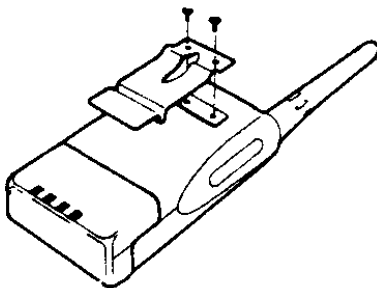

Attach the belt clip to the back of the transceiver using the two screws provided as shown in the diagram on the left.

Attaching the Hand Strap

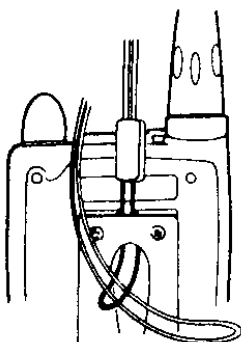

Attach the hand strap between the belt clip and the groove on the back of the transceiver.

Installing and Removing the Ni-Cd Battery Pack

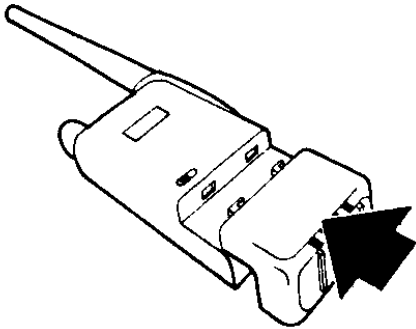

- **Installing the battery pack**

Align the Ni-Cd battery pack with the grooves on the transceiver, and slide it in the direction of the arrow until it clicks into place.

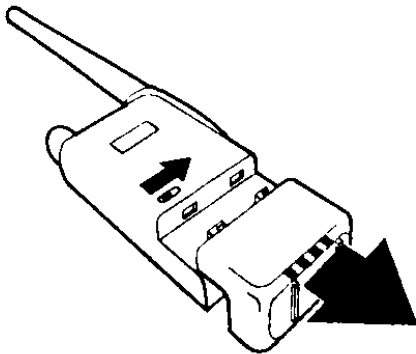

- **Removing the battery pack**

Slide and hold the battery pack release button to the right to release the catches, and gently pull the battery pack free of the transceiver.

- **Recharging the battery pack**



When the remaining battery power is low, the icon shown on the left will appear on the display. Recharge the battery pack when this happens.

- Use the Battery Save (page 47), Auto Power Off (page 46), and Low-power Transmission (page 18) functions to extend battery life.

● Glossary of Terms

● L Band and R Band

The DJ-G5T/E display shows two bands, L Band on the left, and R Band on the right.

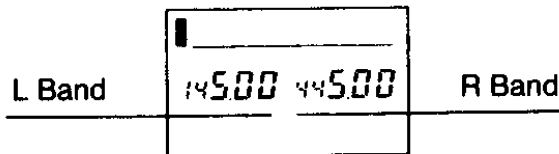

● Main Band and Sub Band

Where  is displayed, the transmission is made on this Main Band, and key operations relate to the Main Band.

Where  is not displayed, the band is called sub-band. It is possible to receive on both main and sub bands at the same time.

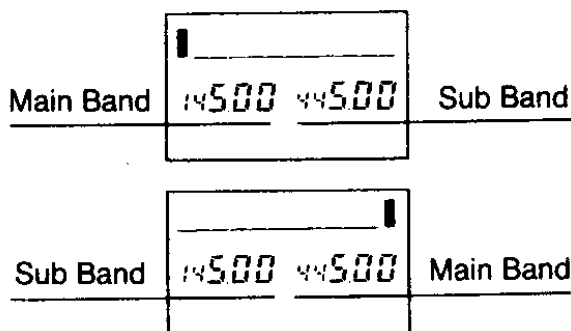

● VHF Band

In this manual, it refers to a frequency range of 108.000 MHz to 173.995 MHz for the DJ-G5T, and a frequency range of 144.000 MHz to 145.995 MHz for the DJ-G5E.

● UHF Band

In this manual it refers to a frequency range of 420.000 MHz to 479.995 MHz for the DJ-G5T, and a frequency range of 430.000 MHz to 439.995 MHz for the DJ-G5E.

● Twin Band and Mono Band

Twin band operation refers to operation of both the L Band and R Band together. Mono Band refers to operation when only one of the bands is used.

● VFO-A and VFO-B

VFO mode on the DJ-G5T/E has two VFO's each for VHF and UHF bands of the L Band and the R Band (for a total of eight VFO).

The two VFO's are called VFO-A and VFO-B.

● Memory Programming Mode and Memory Operation Mode

There are two memory modes; Memory Programming Mode, which displays all memory channels, and allows memory channels to be programmed, and Memory Operation Mode, which allows only programmed memory channels to be called up.

● Scanning

Scanning refers to the process of periodically varying the receive frequency to search for channels on which signals are being transmitted.

● Channel Scope

This originally Alinco feature monitors the displayed frequency, and frequencies around it, and presents a summary of the information on the display.

● Sweep Scan

The sweep function scans a frequency range, and displays the status of the frequencies around the currently scanned frequency.

● Squelch

The squelch function removes audible noise when a signal is not being received. When the squelch is unmuted the received signal audio is output.

- The display and frequency examples used in this manual are for the DJ-G5T. However, operation for the DJ-G5T and DJ-G5E are the same.

● Specifications

General			VHF	UHF
Receiver range (MHz)	DJ-G5T	L-band	108.000 ~ 173.995 (AM, FM)	420.000 ~ 479.995 (FM)
		R-band	130.000 ~ 173.995 (FM)	
	DJ-G5E		144.000 ~ 145.995	430.000 ~ 439.995
Transmitter range (MHz)	DJ-G5T		144.000 ~ 147.995	438.000 ~ 449.995
	DJ-G5E		144.000 ~ 145.995	430.000 ~ 439.995
Modulation			F2E, F3E (FM)	
Ant. impedance			50Ω	
Operating temp. range			-10°C ~ +60°C	
Supply voltage (rated voltage)	External (V)		4.5 ~ 16.0 (13.8)	
	Ni-Cd (V)		4.5 ~ 16.0 (4.8)	
Current consumption (regulated supply voltage)	Tx Hi: 13.8VDC (external)		approx. 1.4A	approx. 1.5A
	Tx Hi: 9.6VDC (Ni-Cd)		approx. 1.4A	approx. 1.5A
	Tx Hi: 7.2VDC (Ni-Cd)		approx. 1.4A	approx. 1.5A
	Tx Hi: 4.8VDC (Ni-Cd)		approx. 1.0A	approx. 1.2A
	Tx Mid: 4.8VDC (Ni-Cd)		approx. 0.8A	
	Tx Lo: 4.8VDC (Ni-Cd)		approx. 0.5A	
	Rx squelched (twin band)		approx. 85mA	
	Rx squelched (mono band)		approx. 50mA	
Rx Battery-Save On (800/200 twin band)		approx. 25mA		
Ground			Negative ground	
Mic. impedance			2kΩ	
Dimensions without projections (with projections)			W57(63) × H138(155) × D27.5(31.5) mm	
Weight (Ant. belt-clip, strap, and Ni-Cd EBP-33N inclusive)			approx. 350g	
Transmitter				
Power output (regulated supply voltage)	Hi: 13.8VDC (external)		approx. 5W	
	Hi: 9.6VDC (Ni-Cd)		approx. 4.5W	
	Hi: 7.2VDC (Ni-Cd)		approx. 3.5W	approx. 3W
	Hi: 4.8VDC (Ni-Cd)		approx. 1.5W	approx. 1W
Modulation			Variable reactance	
Max. deviation			± 5kHz	
Spurious emission			not more than -60dB	
Receiver				
System			Double-conversion superheterodyne	
First I.F.			38.9MHz	45.1MHz
Second I.F.			455kHz	
Sensitivity	DJ-G5T	L-band: 144.000 ~ 147.995MHz	better than -16dB _μ	better than -15dB _μ
		R-band: 438.000 ~ 449.995MHz		
	DJ-G5E	L-band: 438.000 ~ 449.995MHz	better than -12dB _μ	
		R-band: 144.000 ~ 147.995MHz		
	DJ-G5E	L-band: 144.000 ~ 145.995MHz	better than -16dB _μ	better than -15dB _μ
		R-band: 430.000 ~ 439.995MHz		
		L-band: 430.000 ~ 439.995MHz	better than -12dB _μ	
Squelch sensitivity			better than -20dB _μ (0.1μV)	
Selectivity (-6dB/-60dB)			more than 12kHz / less than 30kHz	
A.F. output (@10% distortion)			100mW (8Ω load)	

*Specifications are subject to change without notice or obligation.
 *Specifications guaranteed in the amateur band only.

2. Part Names and their Function

2

• Top

Antenna connector
A BNC connector for connecting the flexible antenna provided with the transceiver. It is also possible to connect an external antenna.

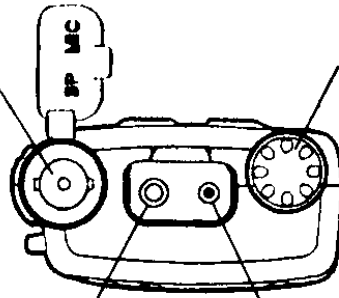

Dial
Used to change the frequency and memory channel, and for changing various settings.

SP connector
For connection of an optional external speaker.

MIC connector
For connection of an Alinco microphone (option).

• Front

Power switch
For switching the power on and off.

SRCH/MONO key
When pressed alone, switches the Channel Scope on and off (page 29).
If pressed while the F key is being pressed, it switches the transceiver between Twin Band and Mono Band (page 12).

Display
Displays the frequency and other operating information.

Keyboard
Each key has different functions (page 7). Also used to enter VFO frequencies (page 15).

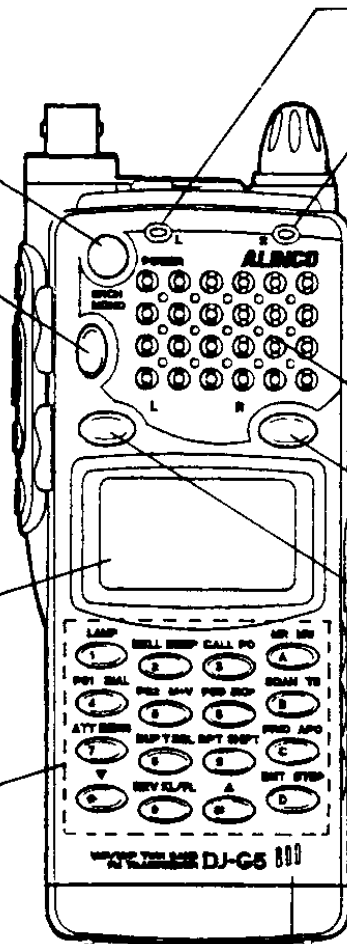

L Band BUSY/ON AIR lamp

R Band BUSY/ON AIR lamp
These lamps light green when a signal is being received, and red when the transceiver is transmitting a signal.

Speaker

R key

L key
Press the key on the side where you want the main band to be.
The transceiver enters VFO mode if it was in Memory/Call mode, and switches between VFO-A and VFO-B if it was in VFO mode (page 13).
If you push the L or R keys while holding down the F key when the transceiver is in VFO mode, the transceiver switches between the VHF and UHF bands (page 41).

Microphone
Speak into the microphone when transmitting.

● Sides

Antenna side

F (function) key
Use this key in combination with the other keys to access various functions of the transceiver.

PTT (press-to-talk) key
While this key is pressed, the transceiver transmits on the main band (page 17).

PTT2 key
With the factory settings, while this key is pressed, the DJ-G5T transmits at low power, and the DJ-G5E performs tone burst transmission. The function of this key can be changed (page 18).

MONI key
Pressing the MONI key temporarily unmutes the squelch, regardless of the squelch setting (page 16). Pressing the MONI key while pressing the F key activates the Battery Save function (page 47).

Dial side

VOLUME ▲/▼ key
Adjusts the audio volume of the main band when pressed alone, and the volume of the sub band when pressed with the F key (page 10).

SQUELCH ▲/▼ key
Adjusts the audio volume of the main band squelch when pressed alone, and the volume of the sub band squelch when pressed with the F key (page 11).

DC-IN
Terminal for connection of an external 13.8 V DC power supply. If you wish to connect the DJ-G5T/E to the cigarette lighter in your car, you must purchase the optional EDC-36 cigarette lighter cable from your Alinco dealer.

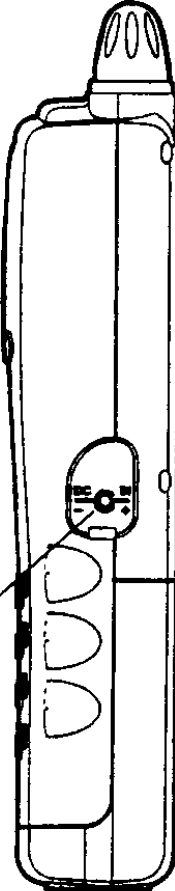
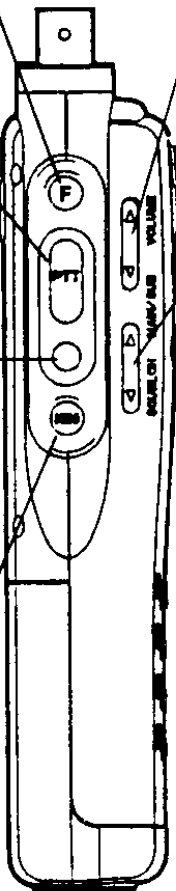

● Rear





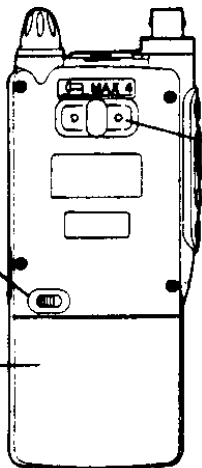











Battery lock button
Slide this button to the right to remove the NiCad battery pack.









NiCad battery pack





Belt clip connector screw holes
Connect the belt clip accessory here (page 1).

● Keyboard

Key	Function when pressed alone	Function when pressed with the F key
LAMP 	Display lamp on/off (page 44)	Lamp always on (page 44)
BELL BEEP 	Bell function on/off (page 44)	Beep on/off (page 43)
CALL PO 	Call mode (page 24)	Transmission output L, M or H (page 17)
MR MW 	Memory mode (page 20) Switches between memory programming and memory operation modes.	Memory write clear (page 21 and 22)
PS1 DIAL 	Programmed scan 1 start and stop (page 27)	Program dial code (page 56)
PS2 M-V 	Programmed scan 2 start and stop (page 27)	Memory write/clear (page 23)
PS3 SKIP 	Programmed scan 3 start and stop (page 27)	VFO mode/AM mode on/off (page 48) (DJ-G5T only) L Band only Memory mode memory skip (page 28)
SCAN TS 	VFO mode band scan (page 24) Memory mode memory scan (page 27)	Switch between Timer and Busy Scan (page 25)
ATT  DSQ 	RF attenuator on/off (page 45)	Setup DSQ mode and codes (page 51)
DUP TSQL 	Full duplex operation (page 41)	Tone and tone frequency setup (page 50)
RPT SHIFT 	Repeater setup (page 39)	Shift/split setup (page 42)
PRIO APO 	Priority watch start and stop (page 37)	Auto power off setup (page 46)
	Frequency/memory down (page 14 and 20)	Memory No. down (page 21)
REV KL/FL 	Reverse (page 40)	Keylock (page 46)
	Frequency/memory up (page 14 and 20)	Memory No. up (page 21)
ENT STEP 	Direct frequency input mode (page 15)	Channel step setup (page 45)

Key	Function when key is pressed while power is switched on
PS1 DIAL 	The Channel Scope function demo mode (page 29)
MR MW 	Switch No. of memory channels (80 or 100) (page 23)
ATT  DSQ 	Switch wait time for DTMF output (450 ms/750 ms) (page 55)
DUP TSQL 	Tone setting allocation for RPT key (page 40)
RPT SHIFT 	Shift setting allocation for RPT key (page 39)
REV KL/FL 	Cross band repeater mode on/off (DJ-G5T only) (page 48)
ENT STEP 	PTT2 key setting (low power, tone burst, or sub band transmit) (page 18)
PS2 M-V 	Cloning mode (over the air) (page 62)

- The function of a key when pressed alone is written in grey to the upper left of the key. The function of a key when it is pressed while the F key is being pressed, is written in green to the upper right of the key.
- Use the 0 to 9, *, #, and the A to D keys for direct frequency entry, DSQ code setting, and dial code setting.
- When using the  or  keys to change the frequency or other settings, holding them down for more than 0.5 seconds makes the setting change continuously.



Note To make a setting by holding a key down and switching the power on, hold both keys down until the display appears.



Key Operation Stipulations

■ With the exception of the items in the list below, all operations relate to the main band ( is on the display).

- Display lamp on/off (page 44)
- Full duplex operation (page 41)
- Dial code programming (page 56)
- Keylock (page 46)
- Memory channel No. switch (page 23)
- PTT2 key allocation (page 18)
- Cross band repeater (DJ-G5T only) (page 48)
- Attenuator on/off (page 45)
- Beep on/off (page 43)
- Auto power off (page 46)
- Battery save (page 47)
- DTMF wait time (page 55)
- Sub band mute (page 47)

■ The following keys complete setting operation:

PTT, PTT2, ,  and  keys

Pressing the band key ( or ) is on the main band completes the setting in progress. Pressing the band key is on the sub band completes the setting in progress, and switches the sub band to main band.

● Display

Some parts of the display are common to both L band and R band, and others apply to one or the other. Items marked with a star (★) in the table are common to both bands.

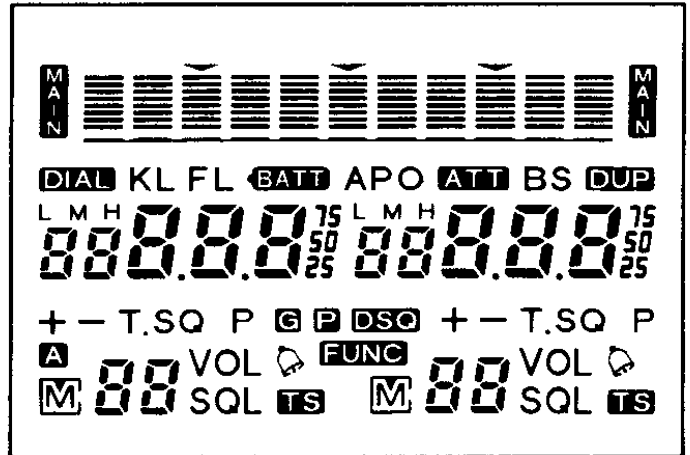

	Main band indicator. (page 12)		Appears during AM reception mode. (DJ-G5T only) (page 48)
★	Appears when auto dial transmission is possible. (page 56)		Appears during memory mode operation. The display changes in memory programming mode. (page 19)
★	Appears during keylock or frequency lock. (page 46)		Indicates VFO-A or VFO-B in VFO mode, and displays the memory No. in memory mode (page 13). Also, temporarily displays the audio volume and squelch levels. (page 10 and 11)
★	Appears when the battery is low and needs recharging. (page 3)		
★	Appears when the auto power off function is on. (page 46)		Appears while the volume is being adjusted. (page 10)
★	Appears when the RF attenuator is on. (page 45)		Appears while the squelch is being adjusted. (page 11)
★	Appears when the battery save function is on. (page 47)		Appears when the bell function is on. Flashes when called. (page 44)
★	Appears during full duplex operation. (page 40)		Appears when timer scan is set. Disappears during busy scan. (page 25)
	Indicates the transmission output power (low, medium or high). (page 17)		Displays the frequency and other settings.
+ -	Indicates the shift/split setting status. (page 42)	★	Appears while the F key is pressed.
	Indicates the tone/tone squelch setting status. (page 50)	★	In twin band operation, the leftmost five level indicators display the received L band levels for the S meter, RF meter, and the Channel Scope. The rightmost five level indicators display the levels for the R band. In mono mode, all 11 indicators display the Channel Scope.
	Appears during priority watch operation. (page 37)		
★	Indicates the main band DSQ setting mode. (page 51)		

3. Basic Operation

1. Turning the Power on and Adjusting Volume and Squelch

Turning the Power on

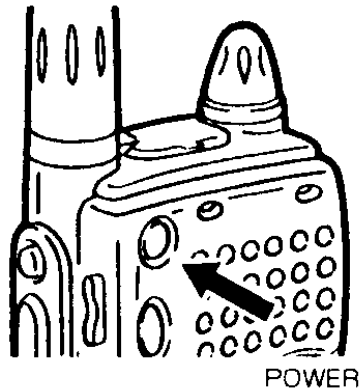

Press and hold the **POWER** switch down for a short time.

The power will come on, and the display will appear.

To turn the transceiver off, press and hold the **POWER** switch down for a short time.

Adjusting the Volume

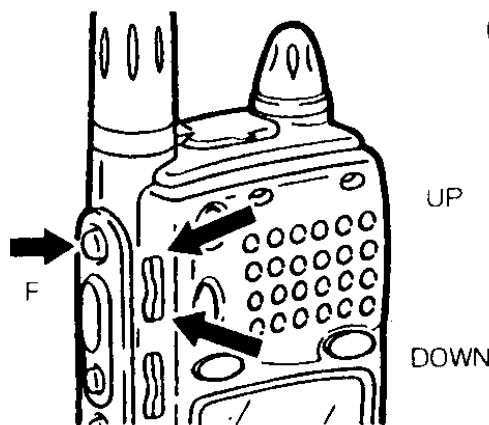

(1) Adjusting the main band volume

Press the **VOLUME** key (**▲ / ▼**) up or down.

When the volume key is pressed, the volume level (0 to 20) of the band on the side of the display that **A** is displayed on, and VOL appear on the display, and the volume changes up or down. Press the **▲** side of the key to increase the volume, and the **▼** side to decrease it.

(2) Adjusting the sub band volume

Press and hold the **F** key and press the **VOLUME** key (**▲ / ▼**) up or down.

When the volume key is pressed, the volume level (0 to 20) of the band on the side of the display that **N** is not displayed on, and VOL appear on the display, and the volume changes up or down. When transmitting on the main band, the volume can be changed with just the **VOLUME** key, there is no need to press the **F** key.

Adjusting the L band volume

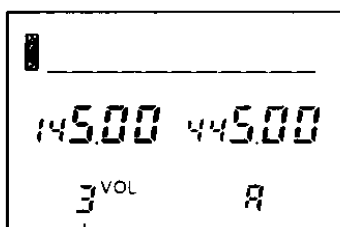

Volume level

In both of the above cases, if there is no key operation for two seconds, the volume level and VOL disappear from the display. The factory setting for the volume is 5.

Adjusting the Squelch

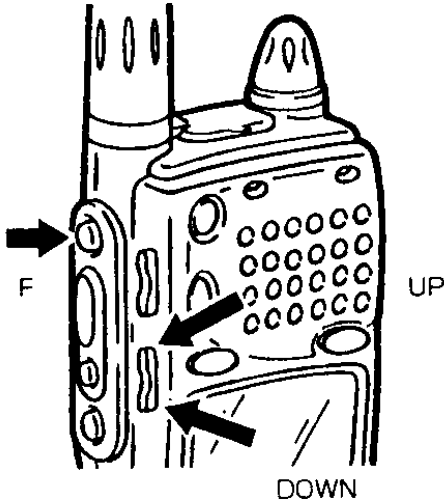

3

Adjusting the L band squelch

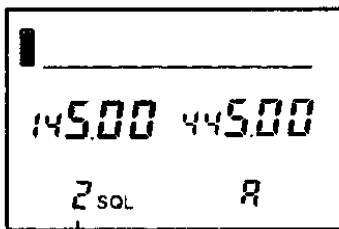

Squelch level

(1) Adjusting the main band squelch

Press the **SQUELCH** key (▲ / ▼) up or down.

When the squelch key is pressed, the squelch level (0 to 10) of the band on the side of the display that  is displayed on, and SQL appear on the display, and the squelch changes up or down. Press the ▼ (down) side of the key to unmute the squelch. You will receive noise. Gradually adjust the squelch in the upward direction by pressing the ▲ (up) side of the squelch key until you cannot hear the noise anymore.

(2) Adjusting the sub band squelch

Press and hold the **F** key and press the **SQUELCH** key (▲ / ▼) up or down.

When the squelch key is pressed, the volume level (0 to 10) of the band on the side of the display that  is not displayed on, and SQL appear on the display, and the squelch changes up or down. When transmitting on the main band, the squelch can be changed with just the **VOLUME** key, there is no need to press the **F** key.

In both of the above cases, if there is no key operation for two seconds, the squelch level and SQL disappear from the display. The factory setting for the squelch is 3.

2. Setting the Main Band

The DJ-G5T/E can receive on the L Band and R Band simultaneously, but transmission and key operations can only be performed on the band designated as the main band (the side on where **M** is displayed). The other band (the side on where **M** is not displayed) is the sub band. When you only wish to operate on one band, it is possible to turn off either the L band or the R band.

Switching the Main Band

Press the sub band key (the key on the side that **M** is not displayed).

The sub and main bands will switch sides.

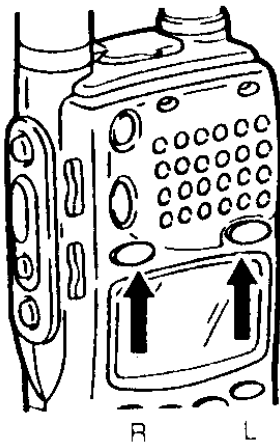

L band is the main band

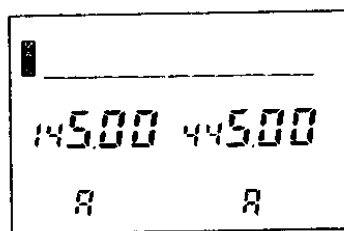

R band is the main band

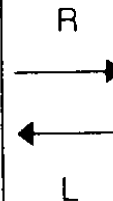
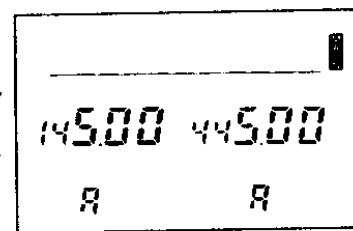

3

Mono Band Operation (operation on one band)

Press the **SRCH/MONO** key while holding down the **F** key.

The sub band side of the display will disappear, and the transceiver will operate on the main band only.

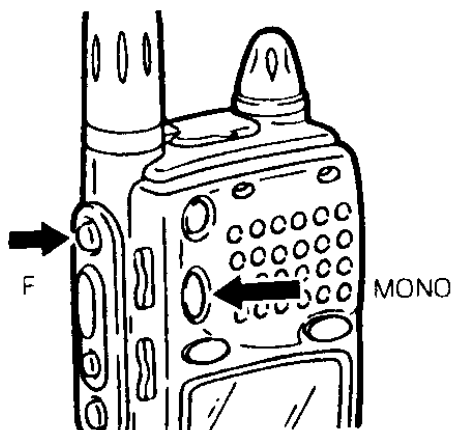

Pressing the band key of the non-operating band when operating in mono band makes that band the active mono band.

L band is the mono band

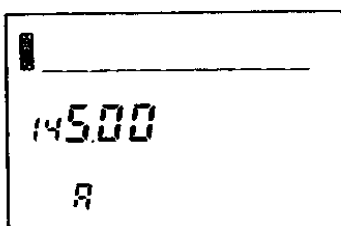

3. The Three Operating Modes

The DJ-G5T/E has three operating modes: VFO mode, Memory mode, and Call mode. The currently active mode is displayed below the frequency display.

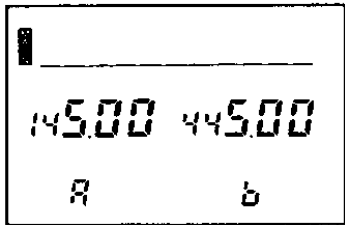

VFO-A VFO-B

(1) VFO mode

The factory setting for the DJ-G5T/E is VFO mode. VFO mode allows the frequencies and other settings to be easily changed. VFO mode has two VFO's, A and B (indicated by icons on the display). Press the main band key to switch VFO-A and VFO-B.

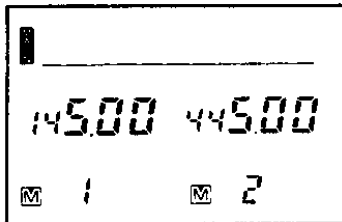

M and the memory No.

(2) Memory mode

In memory mode you call up and operate on previously programmed frequencies. M and the memory No. appear on the display. Memory mode has two modes, programming mode and operating mode (page 19).

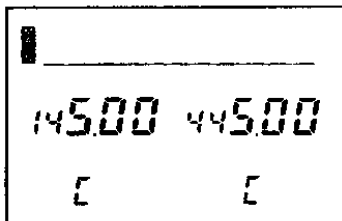

(3) Call mode

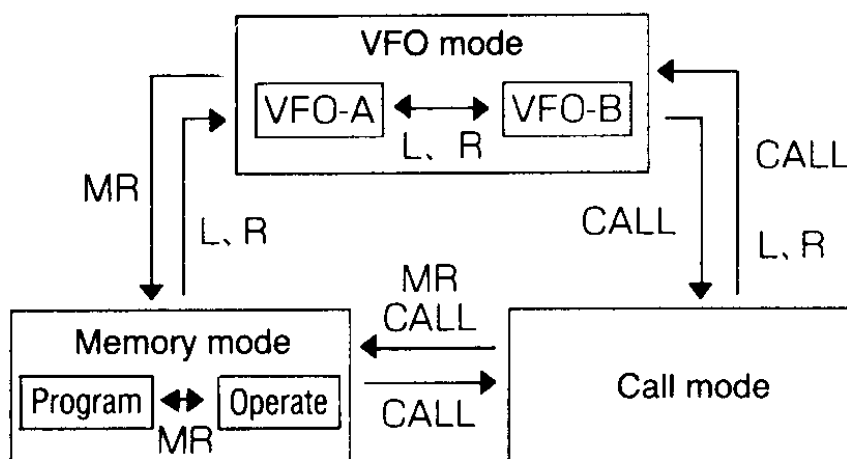

Call mode is used when you are waiting to receive or transmit on the Call channel. There is one Call channel for each of the L and R bands (page 24).

Switching between modes



- **L** and **R** in the diagram refer to the band key for the main band side.
- Pressing the **CALL** key in Call mode returns to the mode selected before Call mode.

4. Setting the Frequency in VFO Mode

In VFO mode, use the **DIAL**, the  /  keys, or the keyboard to for easy frequency entry. The allowed frequency ranges are given in the table on the right.

		DJ-G5T	DJ-G5E
V H F	Receive	L band 108.000 ~ 173.995MHz	144.000 ~ 145.995MHz
		R band 130.000 ~ 173.995MHz	
	Transmit	144.000 ~ 147.995MHz	
U H F	Receive	420.000 ~ 479.995MHz	430.000 ~ 439.995MHz
	Transmit	438.000 ~ 449.995MHz	

Setting the VFO Frequency

- 1 Make the band that you will set the frequency for the main band (page 12)
- 2 Select either VFO-A or VFO-B

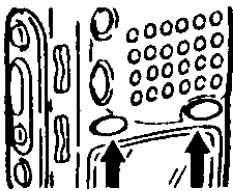



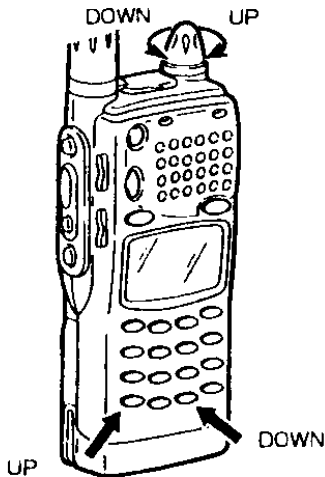

Press the main band's band key.

If you do this in another mode, the transceiver enters VFO mode; if you do it in VFO mode, the transceiver switches between VFO-A and VFO-B.

3 Vary the frequency up or down in one-tuning step units



- ① Rotate the **DIAL**.
Rotate the dial clockwise or counter-clockwise one click at a time to increase or decrease the frequency in one-tuning step unit.
- ② Press the  or  key.
Press the  key to increase the frequency, or  to decrease the frequency in one-tuning step units. Holding either key down for more than 0.5 seconds will cause the frequency to change continuously in that direction.

4 Increasing or decreasing the frequency in 1 MHz steps

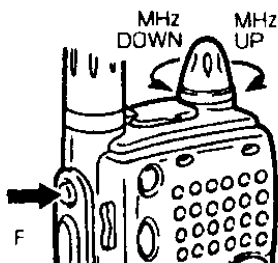

Press and hold the **F** key down and rotate the **DIAL**. Rotate the dial clockwise one click at a time to increase the frequency in 1 MHz steps, and counter-clockwise to decrease it.

5 Entering a frequency using the keyboard

- ① Press the **ENT STEP** key.

Five dashes will appear in the frequency display section, and the transceiver waits for keyboard frequency entry.

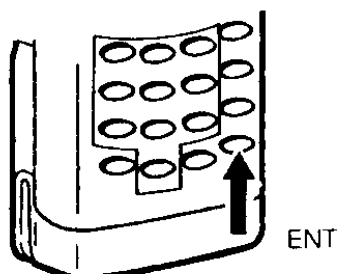

- ② Entering the frequency from the keyboard

Enter the frequency starting from the 100 MHz digit. The entry for the last digit will differ depending on the tuning step (see the table below).

Press the **PRIO APO** key during keyboard entry the return to the previous digit for reentry.

- ③ Exiting during keyboard entry

- After inputting the 1 MHz digit, press the **ENT STEP** key to set the remaining digits to zero and complete the entry.

- To cancel a frequency that is in progress, press either band key or the **PTT** key.

This cancels the entry and returns to the previous frequency entry.

3

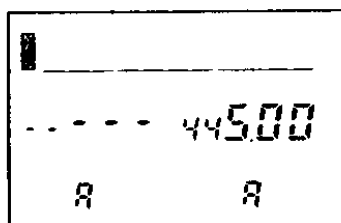

Waiting for keyboard entry

Entry Method for Different Tuning Steps

Depending on the tuning step, entry may be required to the 1 kHz digit or the 10 kHz digit.

Tuning step	Entry completion digit	Entry method for the final digit
12.5 kHz	10 kHz	When you input the 10 kHz digit, the 1 kHz digit is set as follows: 0 00.0 1 12.5 2 25.0 3 37.5 4 invalid 5 50.0 6 62.5 7 75.0 8 87.5 9 invalid
25 kHz	10 kHz	When you input the 10 kHz digit, the 1 kHz digit is set as follows (other entries are invalid): 0 00.0 2 25.0 5 50.0 7 75.0 Other keys are invalid
50 kHz	10 kHz	When you input the 10 kHz digit, the 1 kHz digit is set as follows (other entries are invalid): 0 00.0 5 50.0 Other keys are invalid
Other	1 kHz	Enter 5 for the 1 kHz digit to enter 5 kHz. Any other entry sets the 1 kHz digit to 0.

5. Receiving

1 Adjust the volume (page 10)

2 Adjust the squelch (page 11)

3 Set the frequency (page 14)

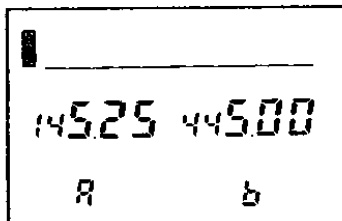

Set the frequency for the main band. Switch the main band and sub band, and set the frequency for the other band.

4 What happens when you receive a signal?

The BUSY/ON AIR lamp light green.

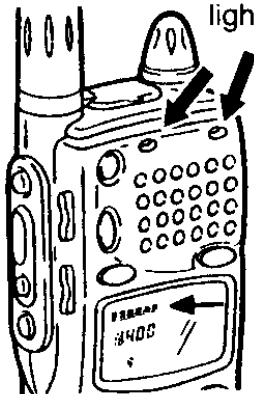

The DJ-G5T/E can receive signals simultaneously on its main band and sub band. The BUSY/ON AIR lamp on the side receiving a signal lights green and the received signal can be heard.

The strength of the received signal is displayed as a bargraph on the S meter.

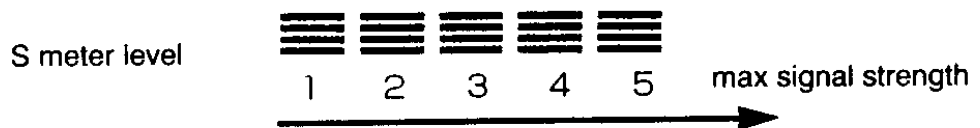

5 What to do if the received signal is weak

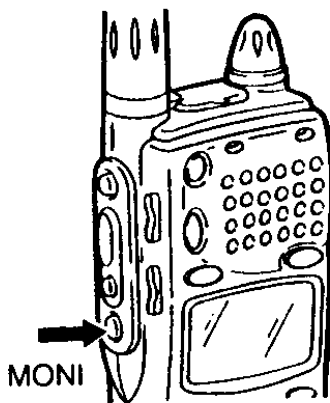

If the received signal is weak or intermittent, press the **MONI** key. While the **MONI** key is pressed, the squelch is unmuted, and the signal will be easier to hear.

The **MONI** key usually only affects the main band, but for the case when (and only when) the **L** band is a VHF frequency and the **R** band is a UHF frequency, the **MONI** key operates on the sub band when pressed during transmission.

6. Transmitting

Transmitting on the Main Band

- 1 Make the transmission band the main band (page 12)
- 2 Set the frequency within the transmission frequency range (page 14)
- 3 Set the transmission output level

3

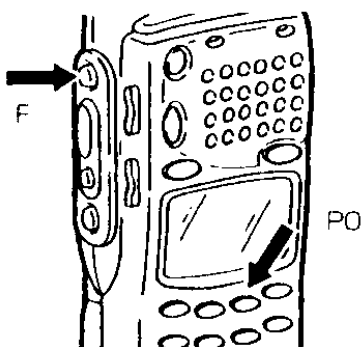

Press the  key while holding the F key down.

The setting changes each time you press the key. Changing the transmission output level changes the output meter display.

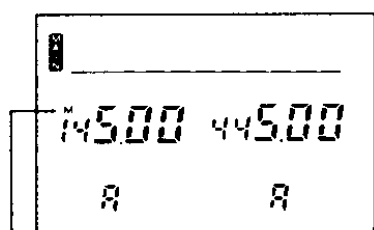

Power indicator icon

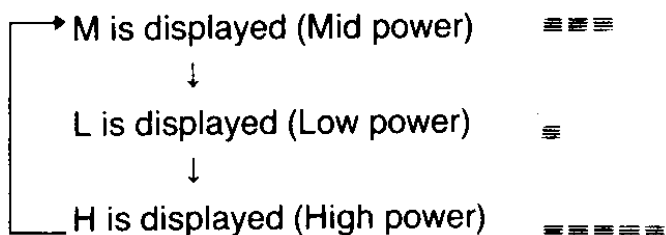

Meter display

4 Transmit

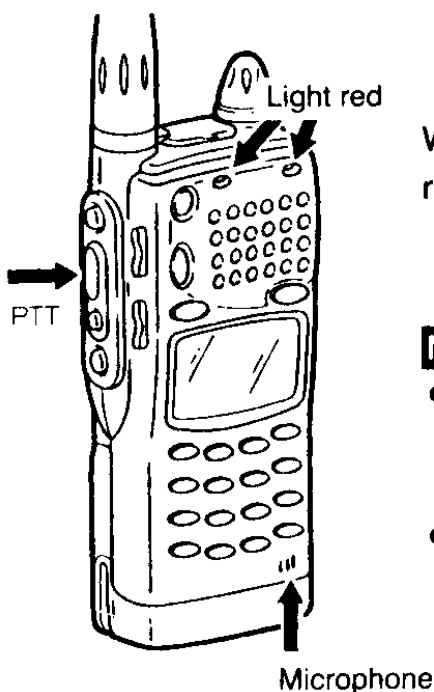

Press the **PTT** key.

When the main band lamp lights red, speak into the microphone. During transmission, the meter display will show the transmission output level setting.

When you release the **PTT** key, the transceiver will revert to receive.

The lamp will go out, or light green if a signal is received.

Note

- Before transmitting, listen for received signals to confirm that your transmission will not interfere with other stations.
- If you attempt to transmit on an invalid frequency, OFF will appear on the display, and transmission will not take place.

Transmitting Using the PTT2 Key

(Low Power, Tone Burst, or Sub Band Transmission)

The **PTT2** key can have one of three functions allocated to it: low power transmission, tone burst transmission, or sub band transmission. The factory settings are low power transmission for the DJ-G5T, and tone burst transmission for the DJ-G5E.

1 Allocating the function of the **PTT2** key

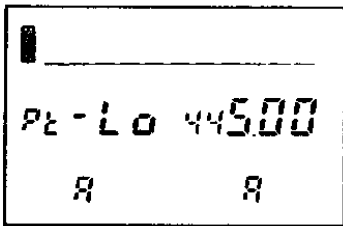

Low power transmission

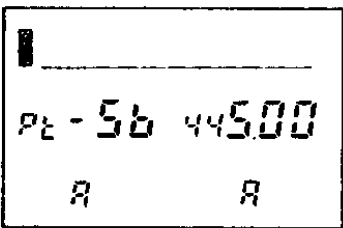

Sub band transmission

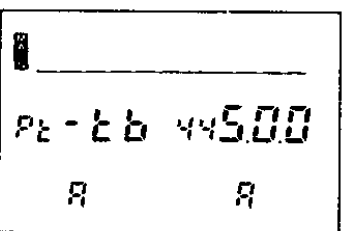

Tone burst transmission

- ① Hold the **ENT** key down, and switch the power on.
The currently allocated PTT2 key function will be displayed on the main band side.
- ② Rotate the **DIAL** or press the **▲** or **▼** keys to change the allocated function.

Low power transmission

The transceiver will transmit at low power, regardless of the output level setting on the main band side. L will appear on the display during transmission.

Sub band transmission

Transmission will be from the sub band. The transmission output level used is the sub band setting.

Tone burst transmission

Transmission from the main band side will have a 1750 Hz tone appended. When the tone encoder is set, the encoder frequency will also be superimposed.

- ③ Press the **PTT**, **ENT**, or main band's band key.
The transceiver will return to the frequency display.
The setting is common for the main and sub bands.

2 Transmit

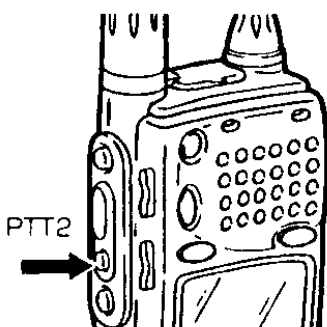

Press the **PTT2** key.

While the key is pressed, the transceiver will transmit using the function allocated to the **PTT2** key.

Note

Sub band transmission is not possible in mono band mode.

4. Memory Channels and Call Channel

1. Memory Channels

The L and R bands of the DJ-G5T/E each have 80 independent memory channels (can be set to a maximum of 100 each), a call channel, and six channels for programmed scans (three pairs). You can program these channels to enable quick and easy recall of frequently used frequencies and operating settings.

Memory types and their factory settings

Type	L band		R band	
	Channel	Initial setting	Channel	Initial setting
General memory channels	1 ~ 80 (00 ~ 99)	None	1 ~ 80 (00 ~ 99)	None
Call channel	C	145.000MHz	C	DJ-G5T 445.000MHz DJ-G5E 433.000MHz
Program scan edge 1	1L, 1H		1L, 1H	
Program scan edge 2	2L, 2H		2L, 2H	
Program scan edge 3	3L, 3H		3L, 3H	

It is possible to increase the number of memory channels from 80 to 100 (page 23).

Data that can be programmed into the memory channels

- | | | |
|--|------------------|----------------|
| ① Receive frequency | ④ Tuning step | ⑦ DSQ mode |
| ② Shift direction and/or split | ⑤ Tone setting | ⑧ DSQ code No. |
| ③ Shift offset and/or transmission frequency | ⑥ Tone frequency | |

Memory channels are used in memory mode. Memory mode on the DJ-G5T/E has two modes, operation mode, and programming mode.

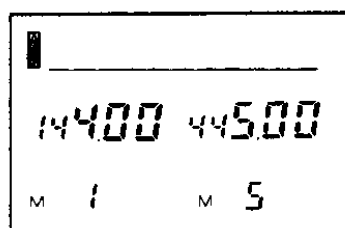

Programming mode
(M icon is displayed)

Programmed memories (indicated by the M icon) and vacant memories (indicated by a flashing M icon and VFO data display) are all displayed in this mode, and memories can be programmed and erased.

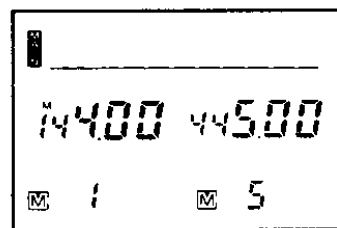

Operation mode
(icon is displayed)

Only programmed memories are displayed in this mode. Use this mode during normal operation. Memories cannot be programmed or erased in this mode.

Calling Up a Memory Channel

1 Set the transceiver to memory mode

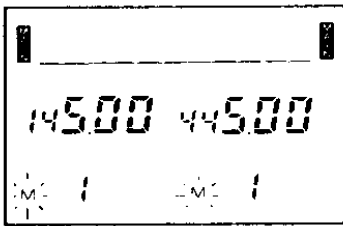
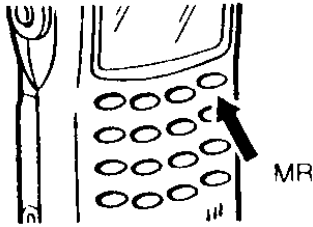

Press the **MR/MW** key in Call mode or VFO mode.

M and the memory number will appear on the display.

When the transceiver is programmed with the factory settings, calling up memory mode will display M1 and the transceiver will be in memory programming mode. Since the memory has not been programmed yet, the M icon will flash and the display will be the VFO frequency and settings thereof.

2 Selecting between programming mode and operating mode

Programming mode

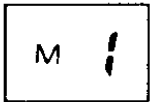

M: programmed memory
Flashing M: vacant memory

Operating mode



M always displayed

Press the **MR/MW** key in memory mode.

Each time the key is pressed the transceiver switches between programming mode and operating mode.

Note, however, when the programming mode memory is vacant (M flashes and the VFO data is displayed), or memory C, or 1L to 3H are displayed, it is not possible to switch to operating mode.

3 Select a memory channel number

In programming mode all memories are displayed. In operating mode, only the programmed memories will appear (M1 to M80, or M1 to M99 and M00).

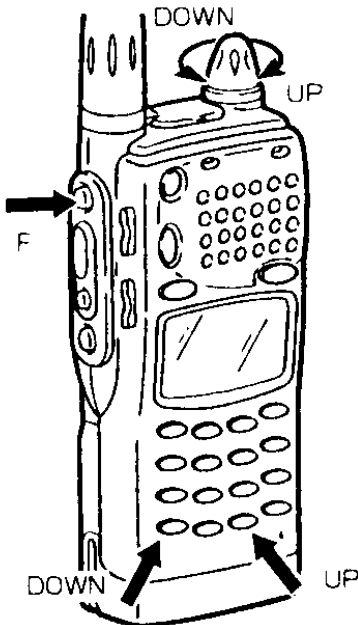

(1) To move up or down one channel.

Rotate the dial clockwise to move up through the memory channels (counter-clockwise to move down). Each click of the dial moves up or down one channel. Alternatively, press the **▲** key to move up one channel, or the **▼** key to move down one channel.

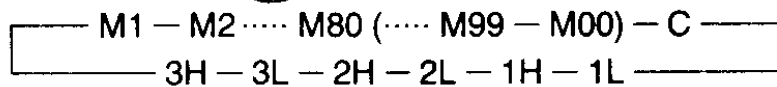

(2) To move up or down 10 channels.

While holding the **F** key down, rotate the dial or press the **▲** or **▼** keys to move up or down by 10 memory channels at a time. The C channel and 1L to 3H channels are not displayed.



Programming a Memory Channel (VFO Mode)

1 Select programming mode when in memory mode (page 20)

2 Go to VFO mode and enter the frequency and other settings (page 14)

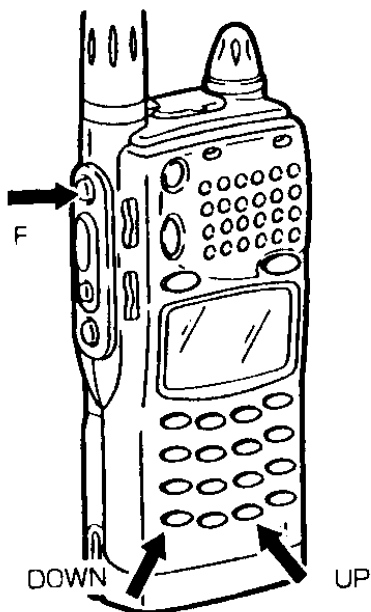
3 Select the memory number that you wish to program



Hold down the F key (**FUNC** appears on the display, and M and the memory number are displayed) and use the  or  keys to select the memory number for programming.

A flashing M indicates that a memory is vacant. When M is not flashing, the memory is already programmed.

4

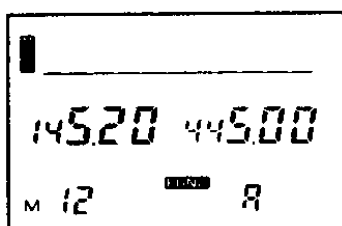

Note

If you select a memory for programming that has already been programmed (M continuously displayed), the new data will be overwritten on the previous data.

4 Program the memory

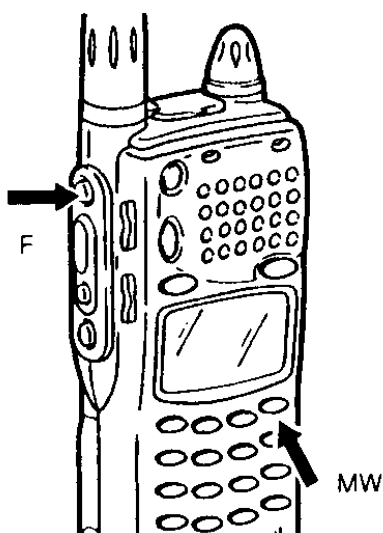

Hold down the F key and press the  key.



The VFO data will be programmed into the selected memory channel.

When you release the F key, the M and memory number display will revert to the VFO-A/B display.

Programming a Memory Channel (Memory Mode)

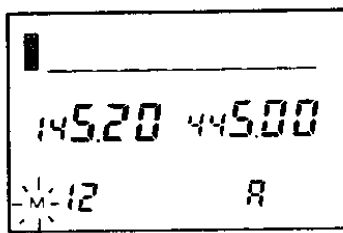
- 1 Enter the frequency and other settings in VFO mode (page 14)
- 2 Go to memory programming mode (page 20)
- 3 Select the memory number (M flashing) that you wish to program



Use the **DIAL** or the  /  keys to change the memory number. Be sure to select a vacant memory (M flashing).

- 4 Program the memory

Hold down the **F** key and press the  key.

The data will be programmed into the memory, and M will stop flashing.

4

Clearing a Memory Channel

- 1 Go to memory programming mode (page 20)
- 2 Select the memory number (M displayed but not flashing) that you wish to clear

Note You cannot clear the C memory or 1L to 3H.

- 3 Clear the memory data

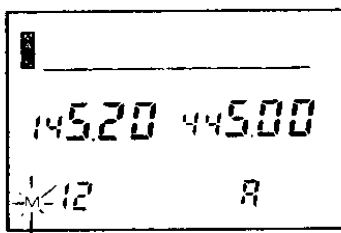

Hold down the **F** key and press the  key.

The displayed frequency and other data will remain unchanged, but M will start to flash indicating that the data is cleared. You can reprogram this same data again by holding down the **F** key and pressing the  key again (M will stop flashing) as long as you do not change items such as memory channels or move to a different mode.

Transferring a Memory to VFO (Memory Shift)

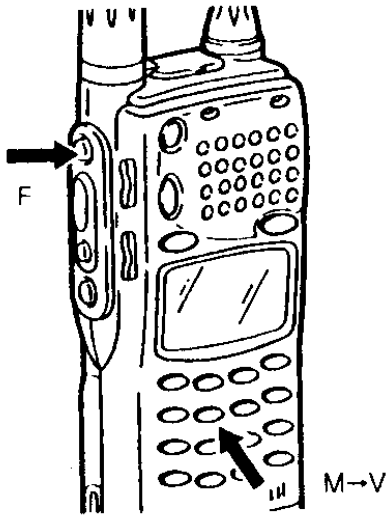

Press the  key while holding the F key in memory mode.

The programmed contents of the memory will be transferred to VFO-A or VFO-B, whichever is currently selected, and the transceiver will enter the VFO mode.

Note

Memory shift is not possible for memories that have split set (page 42).

Setting the Number of Memory Channels

The factory setting for the DJ-G5T/E is 80 memory channels for each of the L and R bands. However, it is possible to increase this to 100 memory channels for each band. Note, however, doing this decreases the number of auto dialer memories (page 56) from 20 channels to 1 channel.

① Switch the power on while holding down the  key.

The number of memory channels set for the currently selected main band is displayed. The setting is the same for the main and sub bands.

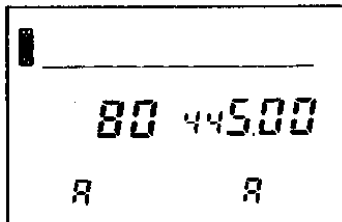

80ch

② Use the **DIAL** or the  /  keys to change the number of memory channels.

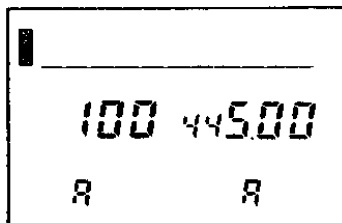

100ch

Note

The number of memory channels cannot be changed in the following cases:

- The current setting is 80 channels, but codes are programmed into one or more of auto dialer channels 2 to 20.
- The current setting is 100 channels, and there is data programmed into channel number 81 or channels after this.

Channel number 100 is displayed as '00' in memory mode.

③ Press the **PTT**, , or main band key.

The transceiver returns to the frequency display.

2. Call Channels

This mode operates on the call frequency (Call channel). The L and R bands have one Call channel each, and the data for the Call channel is programmed into memory C. Memory C can also be used as a regular memory channel. The Call channel allows you to easily call up frequently used frequencies.

Calling Up a Call Channel

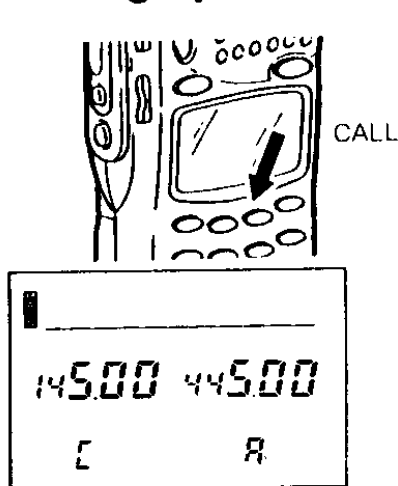

Press the ^{CALL} key.

C appears on the display, and the transceiver enters Call mode. M is not displayed.

Factory settings

	DJ-G5T	DJ-G5E
L band	145.000MHz	145.000MHz
R band	445.000MHz	433.000MHz

Changing the Call Channel's Frequency

- 1 Select memory programming mode in memory mode (page 20)

- 2 Enter the frequency and other settings in VFO mode (page 14)

- 3 Select memory C (page 21)

Hold down the F key and use the ^F or ^F keys to select memory C.

- 4 Program the memory (page 21)

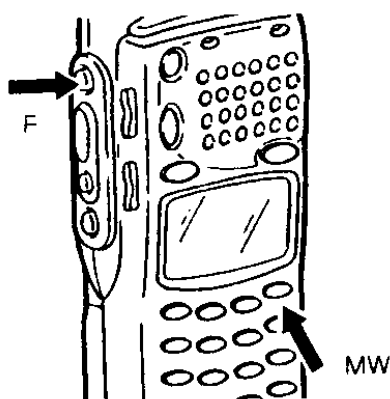

Hold down the F key and press the ^{MW} key.

This programs the new settings into the Call channel. Confirm the settings by pressing the ^{CALL} key.

5. Using the Functions

1. Scans

The scan functions automatically vary the frequency or change memory channels to search for signals being received. The following three scan functions are available.

Function	Operation
Band scan	Scans the entire band in VFO mode.
Programmed scan	Scans between specific low and high edge memory frequencies in VFO mode. Three pairs of programmed scan edge frequencies can be programmed for each of the L and R bands.
Memory scan	Scans the frequencies of the programmed memories.

Setting Scan Resume Conditions

When a signal is received during scanning, the scan stops temporarily. It is possible to select the conditions required for scanning to resume. The scan resume conditions also affect the how the center channel is received when the Channel Scope is operating.

Hold down the **F** key and press the **TS** key.

Each time you press the key, the transceiver switches between timer scan and busy scan on the main band side.

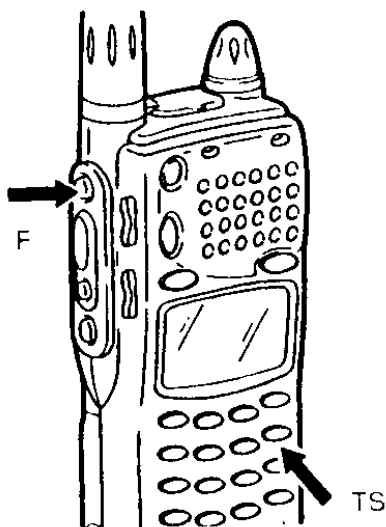

Timer Scan (TS displayed)

Scanning resumes five seconds after pausing or if the signal disappears during that time, whichever comes first. Timer Scan is the factory setting.

Busy Scan (TS not displayed)

Scanning pauses while a signal is received, and resumes two seconds after it disappears.

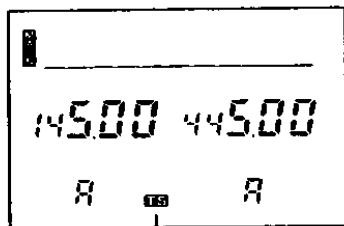

Appears during Timer Scan.
Not displayed during Busy Scan.

Band Scan

1 Start band scan

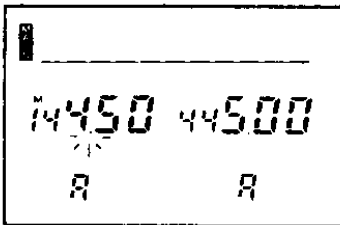
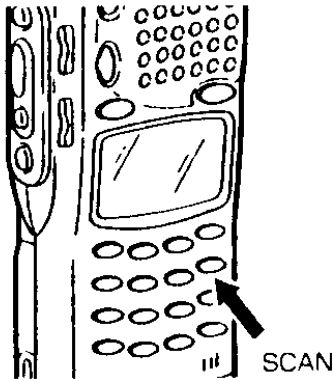

Press the ^{SCAN} **(B)** key in VFO mode.

The transceiver will start scanning the band in the direction of the last operation, at frequencies separated by the tuning step.

The decimal point flashes during scanning. When a signal is received on the displayed frequency, the transceiver receives the signal according to the scan resume conditions.

When scanning in the up direction, when the frequency reaches the top of the band, the transceiver continues scanning from the bottom of the band, and vice versa when scanning down.

2 Stopping a band scan

Press any of the following keys to stop a band scan and return to VFO mode: **PTT**, ^{PS1} **(4)**, ^{PS2} **(5)**, ^{PS3} **(6)**, ^{SCAN} **(B)**, or the main band key.

5

Programmed Scan

PS1 : scans between 1L and 1H
PS2 : scans between 2L and 2H
PS3 : scans between 3L and 3H

1L and 1H are edge memories for Program Scan No. 1 (PS1), and likewise for 2L/2H, and 3L/3H

The transceiver scans frequencies between the programmed edge memories. The scanning frequencies are separated by the tuning step.

1 Program the band edge frequencies into memory

- ① Select one of the three edge memories (1, 2, or 3).
- ② Program the lower edge frequency into the edge memory (1, 2, or 3) (page 20).
- ③ Program the upper edge frequency into the edge memory (1, 2, or 3) (page 20).

Note

- Make sure that you program the memories correctly in pairs (1L/1H), (2L/2H), and (3L/3H).
- The L and H frequencies must be both in the same band (UHF or VHF), and L must be lower than H. If these conditions are not satisfied, a band scan will be performed instead.

2 Start a programmed scan

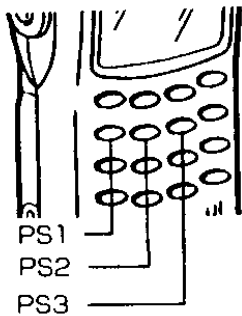

Press one of the , or keys in VFO mode. When the VFO band and the programmed scan band are different, the transceiver switches to the programmed scan band and starts scanning. The display and operations are the same as for band scan. "P1, P2 or P3" flashes during scan.

3 Stopping a programmed scan

Press any of the following keys to stop a programmed scan and return to VFO mode: PTT, , or the main band key.

Memory Scan

1 Starting a memory scan

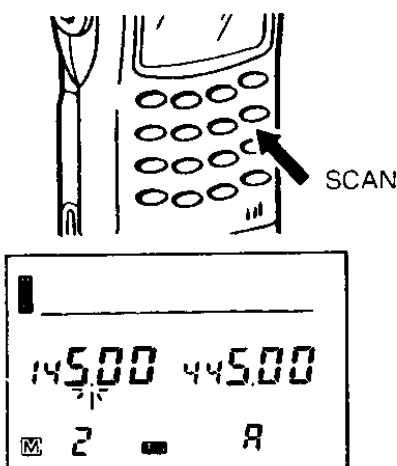

Press the key in memory mode.

The transceiver will start scanning only the programmed memories in the direction of the last operation.

The decimal point flashes during scanning. When a signal is received on the displayed memory channel, the transceiver receives the signal according to the scan resume conditions.

Note

Scanning changes memory mode to operating mode if the scan is started in programming mode. Memory C, and 1L to 3H are not scanned.

2 Stopping a memory scan

Press any of the following keys to stop a memory scan and return to memory mode: PTT, , or the main band key.

3 Setting memories that you do not want scanned (memory skip)

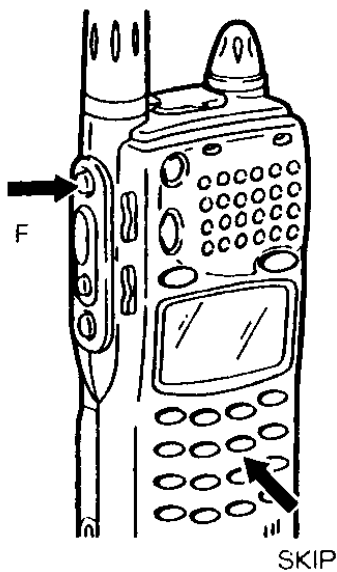

Press the  key while holding down the F key in memory mode.



The decimal point of the frequency will disappear, and this memory will not be scanned during memory scan, or monitored when the Channel Scope is operating.

Repeat the above operation to deactivate memory skip for a memory channel.

Note

This cannot be done during memory scan, or when the Channel Scope is operating.



Operations during scanning, and other points to note

- Use the dial or the  /  keys to change the scan direction.
When a signal is being received, and scanning has paused, the transceiver will go to the next frequency and resume scanning.

- If you transmit on the other band during scanning, the scan will be interrupted. When you finish transmitting, scanning will resume from the point that it was interrupted.

- If you press the  key, scanning and priority watch start operating in parallel (page 38).

- Press the  key to start a sweep scan (page 34).

- Press the  and  band keys to switch the main band.
Pressing the sub band side key makes it the main band while continuing to scan. Therefore, in twin band operation, scanning will be done simultaneously on both bands.

- Scanning when tone squelch and DSQ are set.
 - When tone squelch is set and a signal is received, scanning pauses, and if the tones match, the received signal will be audible.
 - When DSQ is set, it is temporarily disabled during scanning. If a signal is received, scanning pauses even if the codes do not match, and the received signal will be audible.

2. Channel Scope

The Channel Scope function allows you to monitor signal reception levels of other frequencies while receiving a signal on the displayed frequency.

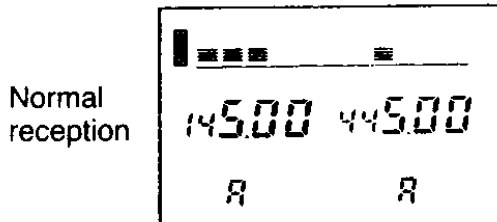

The signal strength of the displayed frequency is displayed horizontally.

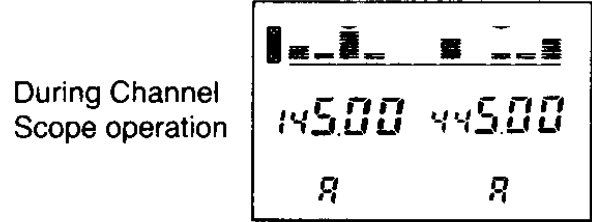

For each band, the signal strengths of five channels around and including the center frequency (marked with ▼) are displayed vertically.

Note Some key entries are disallowed during the Channel Scope. Turn off the Channel Scope in such a case.

Reference Channel Scope demonstration mode
Turn the power on while holding down the  key. The Channel Scope display (only) will be demonstrated (neither the receiver nor the transmitter is working, and key entry is disallowed). Turn the power off to release this mode.

• How the Channel Scope works

The Channel Scope displays the received signal levels of channels around the center channel (no audio).

The transceiver receives on the center channel, and outputs audio if there is a signal.

- If there is no signal on the center channel, the signal level displays of the Channel Scope are continuously refreshed.
- If there is a signal on the center channel, the signal is received according to the Timer/Busy scan settings (page 25).
- When timer scan is set, the level displays for the frequencies around the center channel are refreshed once every five seconds while the center channel is being received, so the audio received on the center channel will be momentarily and periodically interrupted.
- When busy scan is set, channels around the center channel are not refreshed while the transceiver is receiving on the center channel.

• Channel Scope Types

(1) Twin band and mono band

In twin band operation, the signal strengths for each band are displayed on five vertical bars. In mono band operation, the Channel Scope uses 11 bars.

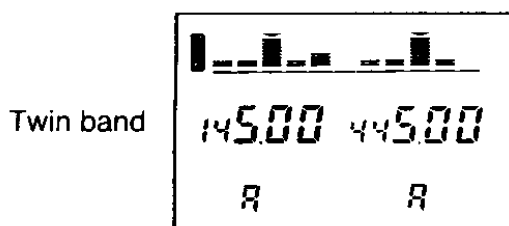

The center channels for each band are indicated by the ▼ mark.

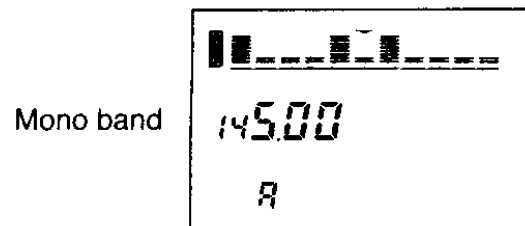

The ▼ mark in the center is the center channel.

(2) There are two types of scope operation, VFO scope, and memory scope. Which operates depends on the mode you were in when the Channel Scope was started.

VFO Channel Scope

The displayed frequency is the center channel, and the receive levels of the channels around the center channel separated by the channel step are displayed by the Channel Scope.

1 Starting and stopping

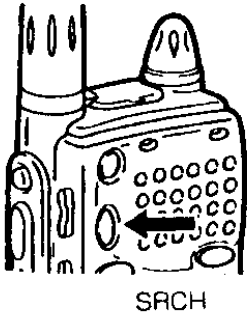

Press **SRCH** in VFO mode.

Reception starts in the Channel Scope mode.

While the signal on the displayed frequency (center channel) is received, the levels of the channels around the center channel at channel step intervals are displayed on the scope (in twin band operation, two channels above and below the center channel).

Press **SRCH** again to stop the Channel Scope.

2 Understanding the VFO scope display

Example: Twin band operation, main band is L, and the tuning step is 20 kHz.

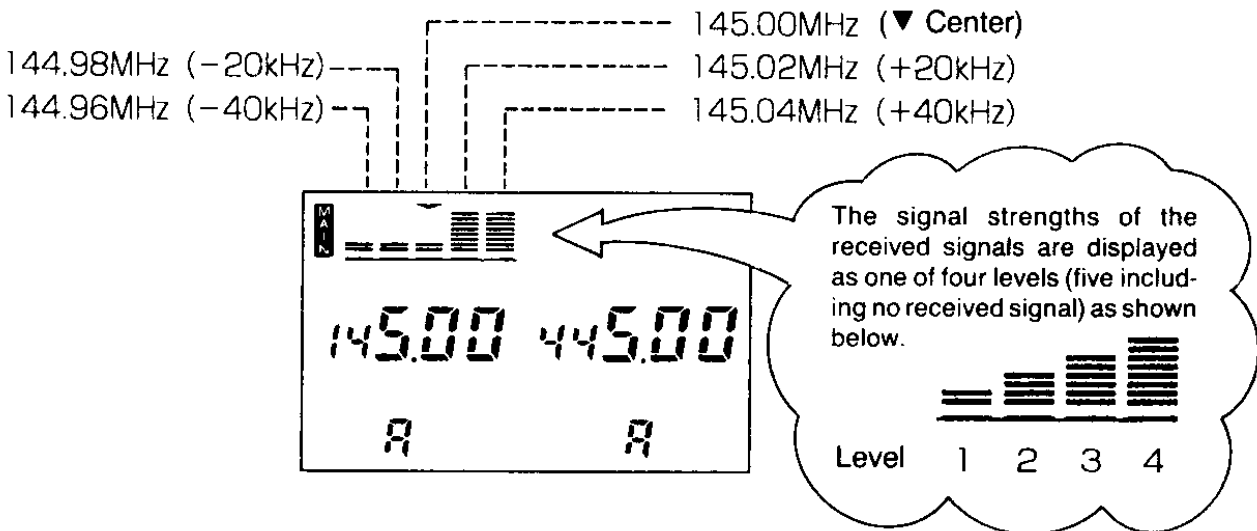

5

Note

- Channels with frequencies above or below the receiver range are not displayed.

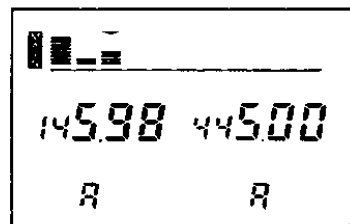
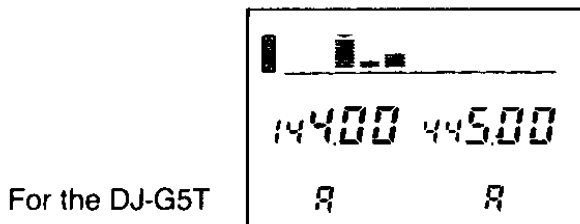

- During mono band operation, 11 levels including the center channel are displayed.

3 Changing the center frequency

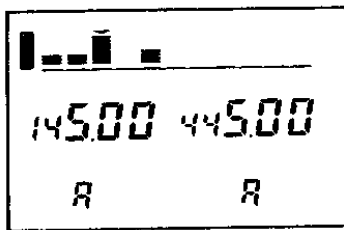

↓ UP

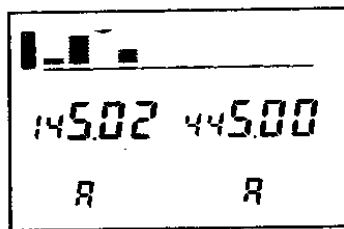

Rotate the **DIAL**, or press the or keys.

The center channel frequency will move up or down by one tuning step, and the other frequencies being monitored by the scope will shift to the left or right accordingly.

Rotating the **DIAL** while holding down the **F** key moves the center channel frequency up or down in steps of 1 MHz, and the Channel Scope will begin monitoring the channels around the new center channel.

Memory Channel Scope

The displayed memory frequency becomes the center channel, and the Channel Scope monitors the adjacent programmed channels above and below the center channel.

1 Starting and stopping

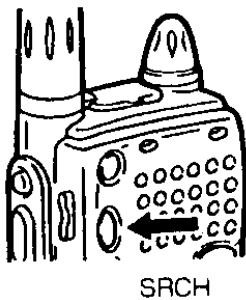

Press the key in memory mode.

Reception starts in the Channel Scope mode.

While the signal on the displayed memory channel (center channel) is received, the levels of the programmed memory channels around the center channel are displayed on the scope.

Press again to stop the Channel Scope.

Note

- Memory C, 1L to 3H, vacant memories, and skip-memories (page 28) are not monitored by the Channel Scope. If the Channel Scope is started while any of these channels are displayed, the Channel Scope will move to the closest valid memory channel and start operation (the direction that it moves to is determined by the direction of the last up/down operation).
- The Channel Scope changes to memory operation mode, if it is started in memory programming mode.

2 Understanding the memory scope display

Example: Twin band operation, main band is **R**, and only the odd channel numbers are programmed.

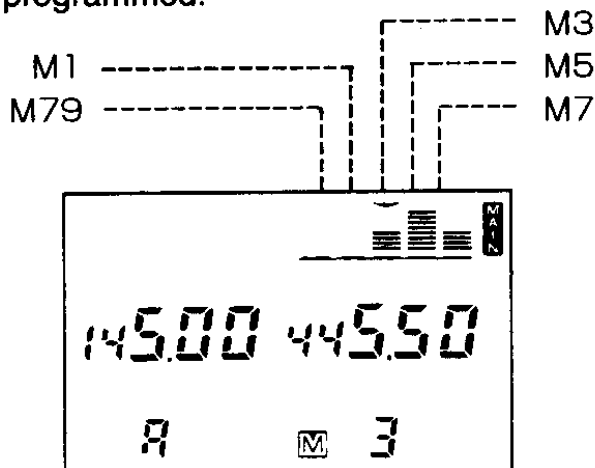

The level display is the same as that for VFO scope.

Note

- During mono band operation, 11 levels including the center channel are displayed.
- The displayed memory channels can loop around past the maximum and minimum memory channel numbers.
- When number of memory channels to be displayed is less than five (11 in mono band), channels blank level(s) will be present.

3 Changing the center frequency

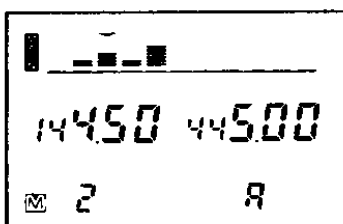

↓ UP

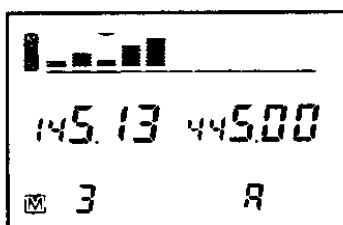

Rotate the **DIAL**, or press the  or  keys.

The center channel memory will move up or down, and the other memories being monitored by the scope will shift to the left or right accordingly.

Operations during the Channel Scope operation, and other points to note

- Pressing the **PTT** key to transmit.

The Channel Scope is temporarily interrupted during transmission. The transmission output level is displayed horizontally on the scope display section. When you stop transmitting, the Channel Scope operation resumes.

- If you transmit on the other band while the Channel Scope is operating, the Channel Scope is temporarily interrupted (disappears from the display) during transmission. When you stop transmitting, the Channel Scope operation resumes.

- If you press the ^{REV KL/FL} **(G)** key, the Channel Scope operation starts from the beginning.

- Press the ^{PRIO APO} **(C)** key to switch between audio ON and OFF on the center channel.

ON: Audio is output when the center channel receives. The time period that it receives for is according to the Timer/Busy scan setting. When the Channel Scope is started it is in the audio-on mode.

OFF: Only the level is displayed for the center channel, in the same way as the other channels. Scope levels are updated continuously. No audio is output, even if a signal is received.

- Pressing any one of the ^{PS1} **(4)**, ^{PS2} **(5)**, ^{PS3} **(6)**, or ^{SCAN} **(B)** keys during VFO scope, or the ^{SCAN} **(B)** key during memory scope starts a sweep scan (page 34).

- Press the ^L **(L)** and ^R **(R)** band keys to switch the main band.

Pressing the sub band side key makes it the main band while the Channel Scope continues to operate. Therefore, in twin band operation, the Channel Scope can be operated simultaneously on both bands.

- During VFO scope operation, it is possible to change bands, switch between VFO-A and VFO-B, and switch between VFO and memory modes. It is not possible to operate the ^{CALL PO} **(S)** key, and **F** with ^{MR MW} **(A)**, ^{PS3 SKIP} **(6)** and ^{ATT} **(7)** keys.

- Channel Scope operation when tone squelch and DSQ are set:

(Reception on the center channel when in audio-on mode)

- When tone squelch is set and a signal is received with the matching tone, the received signal will be audible.
- When DSQ is set, the DSQ is temporarily disabled when the Channel Scope is operating. If a signal is received, the Channel Scope pauses even if the tones do not match, and the received signal will be audible.

3. Sweep Scan

The sweep scan function displays the received signal levels as it scans. The level of the previously scanned level remains, even after the scan moves to the next channel. There are three types of sweep scan, Band Sweep Scan, Programmed Sweep Scan, and Memory Sweep Scan, the same as the normal scan function.

Band Sweep Scan

Sweep scans the entire band.

1 Starting a band sweep scan





Perform the following operations in VFO mode (the order may be ① → ② or ② → ①).

① Press the  key.

② Press the  key.

The sweep scan will start scanning frequencies at set tuning step intervals in the direction of the most recently performed operation. The decimal point flashes during scanning, and when a signal is received on a displayed frequency, the scan will resume according to the scan resume conditions.

2 Stopping a sweep scan

Press any one of the PTT, , , , , keys or the main band key to go to the Channel Scope.

Press the  key to go to band scan.

3 Understanding the sweep scan level display

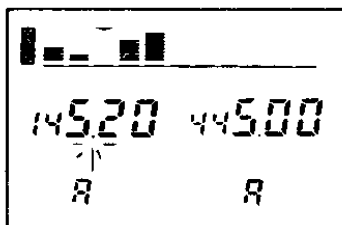

↓ UP

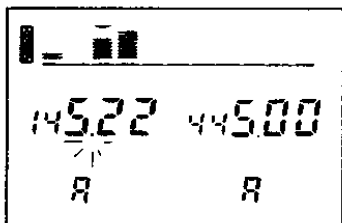

Example: Sweep scanning in the up direction with a tuning step of 20 kHz.

The frequency keeps going up the set tuning step, and displays the level as it goes.

The level display from the left is as follows:

– 40 kHz

– 20 kHz

▼ Displayed frequency

+ 20 kHz

+ 40 kHz

Likewise if scanning downward.

Programmed Sweep Scan

Sweep scans the frequency range between edge memories.

1 Start a programmed sweep scan

Perform the following operations in VFO mode (the order may be ① → ② or ② → ①).

① Press the one of the ^{PS1}4, ^{PS2}5, ^{PS3}6 keys.

② Press the ^{SRCH}MONO key.

2 Stopping a programmed sweep scan

Press any one of the PTT, ^{PS1}4, ^{PS2}5, ^{PS3}6, ^{SCAN}8, or the main band key to go back to the Channel Scope.

Press the ^{SRCH}MONO key to go to programmed scan.

3 Understanding the sweep scan level display (page 34)

The level display is the same as for the band scan.

Memory Sweep Scan

A memory Sweep scans the frequencies in the programmed memories.

1 Start memory scan

Perform the following operations in VFO mode (the order may be ① → ② or ② → ①).

① Press the ^{SCAN}8 key.

② Press the ^{SRCH}MONO key.

2 Stopping a programmed sweep scan

Press PTT or the ^{SCAN}8 key to go back to the Channel Scope.

Press the ^{SRCH}MONO key to go to memory scan.

3 Understanding the sweep scan level display

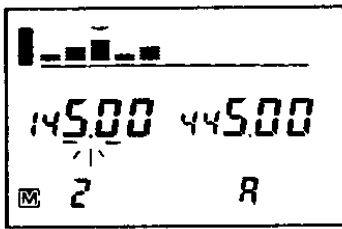

↓ UP

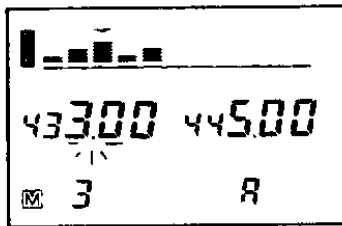

Example: Sweep scanning in the up direction.

The transceiver steps up through the programmed memories one at a time, and displays the level as it goes.

The level display from the left is as follows:

- 2 ch

- 1 ch





▼ Displayed memory channel

+ 1 ch

+ 2 ch

Likewise if scanning downwards.

Operations during sweep scanning, and other points to note

- Use the **DIAL** or the  /  keys to change the scan direction.
- During sweep scanning if you transmit on the other band, the scan will be interrupted. When you finish transmitting, the sweep scan will resume from the point that it was interrupted.
- Press the  key to switch between audio on/off for reception on the center channel (displayed frequency) (page 33).
- Press the  and  band keys to switch the main band.
Pressing the sub band side key makes it the main band while continuing to scan. Therefore, in twin band operation, sweep scanning can be activated on both bands.
- Scanning when tone squelch and DSQ are set. (Audio-on mode)
 - When tone squelch is set and a signal is received with the matching tone, and the received signal will be audible.
 - When DSQ is set, the DSQ is temporarily disabled during scanning. If a signal is received, sweep scanning pauses even if the tones do not match, and the received signal will be audible.

4. Priority Watch

When the priority watch function is operating, in addition to receiving the displayed frequency, the transceiver monitors a 'priority' channel. Every five seconds, the transceiver switches from the displayed frequency to the priority channel and receives on it for 0.2 seconds. If a signal is received on the priority channel, the reception time is extended to two seconds. The following three types of priority watch are available.

Type	Start mode	Display frequency (5 sec.)	Priority channel (0.2 sec.)
VFO priority watch	VFO	VFO	Memory
Memory priority watch	Memory	Memory	VFO
Call priority watch	Call	Call	VFO/Memory*

*The frequency before calling up Call channel is the priority channel.

VFO, Memory and Call Priority Watch

1 Start priority watch

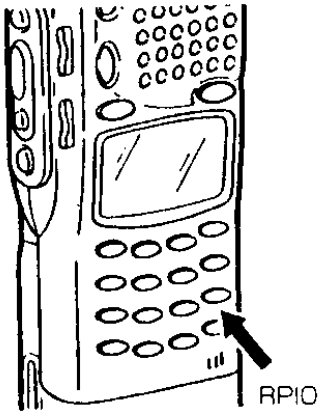

- ① Select the priority channel that you wish to receive.
- ② Call up the mode that you want to receive for five seconds on.
- ③ Press the  key.

P appears on the display, and priority watch operation starts. After receiving for five seconds in the mode that priority watch was started in, the transceiver switches to the priority channel and receives on it for 0.2 seconds. If a signal is received on the priority channel, an alarm sounds, and the reception time is extended to two seconds.

Example: VFO priority watch

VFO mode 5 sec. side

Memory mode 0.2 sec. side

(2 seconds when a signal is received)

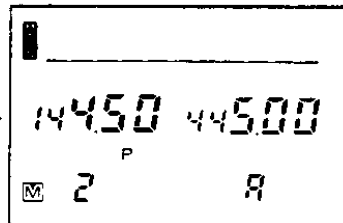
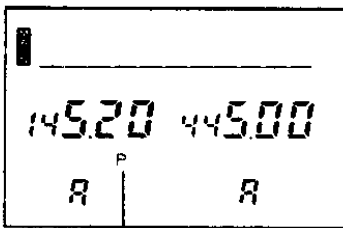

P is displayed

Memory and Call priority watch are the same except the 5 sec./0.2 sec. receive channels are different.



2 Stopping priority watch











Press the main band side band-key, or press the  key when receiving on the five second side, or the **PTT** key when receiving on the 0.2 second side.

Operations during priority watch, and other points to note



- Press the **PTT** key during the five second side to transmit. The transceiver will not switch to the 0.2 second side while you are transmitting.

- If you transmit on the other band during priority watch, priority watch will be interrupted. When you finish transmitting, priority watch will resume from the point that it was interrupted.

- In VFO priority watch or memory priority watch, rotate the dial or use the  or  keys to change the frequency or memory channel.

- Simultaneous operation of priority watch and scanning.
 - Starting**
 - Press the  key during the five second side during VFO priority watch to start band scan, or press one of the , , or  keys to start a programmed scan.
 - Press the  key during the five second side during memory priority watch, to start a memory scan.
 - Stopping**
 - Press one of the **PTT**, , ,  or  keys during the five second side of a band or programmed scan to stop the scan, but stay in priority watch.
 - Press either the **PTT** or  key during the five second side of a memory scan to stop the scan, but stay in priority watch.
 - Press the  key during the five second side of a band, programmed, or memory scan to stop priority watch, but continue the scan.
 - Press the **PTT** key during the 0.2 second side to stop both the priority watch and the scan.

- The Channel Scope cannot be used during priority watch.

- Press the  and  band keys to switch the main band.

Pressing the sub band side key makes it the main band while continuing priority watch. Therefore, in twin band operation, priority watch can be set on both bands.

- Receiving on 0.2 second mode when tone squelch and DSQ are set.

The conditions for extending the reception time in 0.2 second mode are the same as the pause conditions during scanning (page 28).

5. Repeater

Setting up the DJ-G5T/E for repeater operation

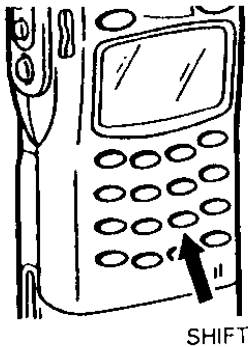

Press the **RPT** key.

This sets the shift and tone, previously allocated to the key.

Press the **RPT** key again to cancel the setting.

This cancels the both the shift and tone.

Allocating a setting to the RPT key

Allocate a shift and tone that matches the repeater station that you will use to the **RPT** key. It is possible to make settings for both the **L** and **R** bands.

1 Set the shift and shift width (refer to page 42)

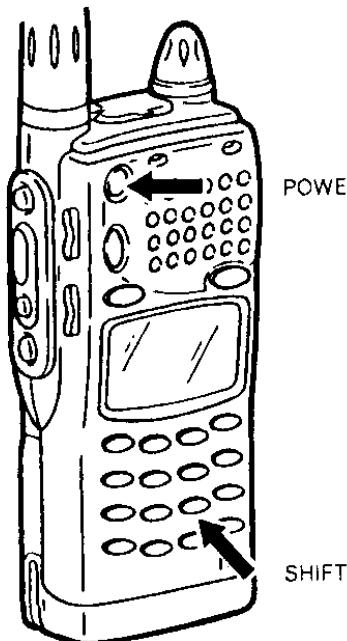

- ① Hold down the **RPT SHIFT** key and turn the power on.
The shift direction and shift width allocated to the **RPT** key for the main band side are displayed.
- ② Setting the mode.
Hold down the **F** key and press the **RPT SHIFT** key.
This sets either - shift, + shift, or cancels the shift.
Split (+ -) is not displayed.
- ③ Set the shift width.
Rotate the **DIAL** or press the **▲** key or the **▼** key.
The shift moves up or down in 100 kHz units.
- ④ Press one of **PTT**, the **ENT** key, or the main band's band key.
The transceiver returns the frequency display.

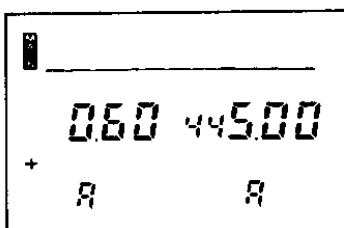

2 Set the tone and tone frequency (refer to page 50)

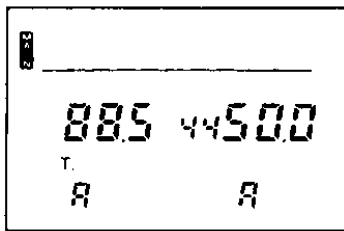
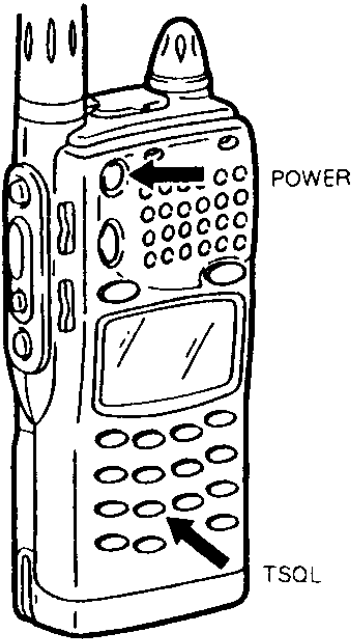

Some repeaters require CTCSS tone with the uplink signal. In this case

- ① Hold down the ^{DUP TSQ} key and turn the power on.
The tone width and tone frequency allocated to the **RPT** key for the main band side are displayed.
- ② Setting the mode.
Hold down the **F** key and press the ^{DUP TSQ} key.
Set either **T** (tone encoder), or no tone (no display).
Do not set **TSQ** (tone squelch), as this may not work well through a repeater.
- ③ Set the tone frequency.
Rotate the **DIAL** or press the ⁶ key or the ⁴ key.
- ④ Press either the **PTT**, the ^{ENT} key, or the main band's band key.
The transceiver returns the frequency display.

Reverse (Receiving on the Transmit Frequency)

This function receives on the transmit frequency to check if it is possible to communicate using a repeater. If reception is possible in reverse mode, possibly you can communicate without using a repeater.

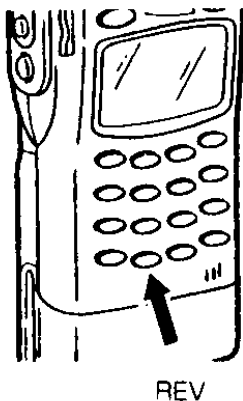

Press the ^{REV} key.

While the key is pressed, the transceiver receives on the transmit frequency. Only the frequency part of the display changes.

Note

This will not work if shift and split are not set, or if the result of the reverse test happens to be outside the band range.

6. Twin-Band Reception

Simultaneous Reception on the Same Band

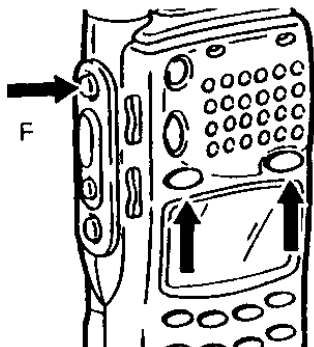

Example:
Simultaneous reception on
the VHF band.

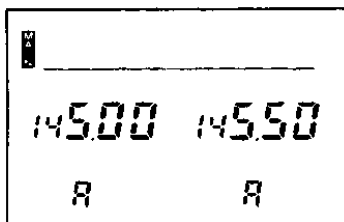

During VFO mode, hold down the **F** key and press the main band's band key. Each press of the key switches the transceiver between the UHF and VHF bands.

In this manner, switching **R** band to VHF makes both sides VHF, or switching **L** band to UHF makes both sides UHF.

Note

- If the frequency band combination is anything other than VHF (on L-band) and UHF (on R-band), you cannot receive on one band while transmitting on the other.
- The receive frequency ranges for the DJ-G5T's **R** and **L** bands are different.
- AM cannot be received on R band.

Full Duplex Operation

Because the DJ-G5T/E allows you to receive on the sub band while transmitting on the main band, communicating with it feels much like talking on the telephone (in this case, the **L** band must be VHF, and the **R** band UHF).

When using the DJ-G5T/E in this way, howling tends to occur more easily. To prevent this, use the procedure described below to reduce the volume of the received signal, and the microphone sensitivity.

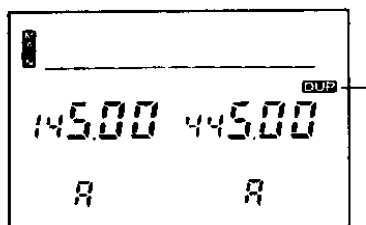
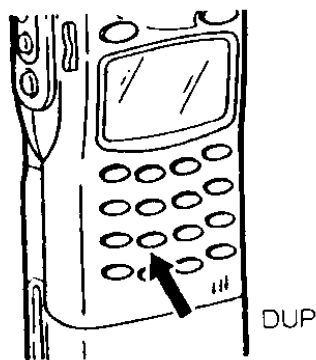

DUP appears

Press the ^{DUP} key.

DUP appears on the display, and the transceiver is set to full duplex operation (valid for both bands).

Press ^{DUP} again to cancel the setting.

Note

- The above input is always accepted (**DUP** will appear in the display), but it actually operates only when the **L** band is a VHF frequency and the **R** band is a UHF frequency.
- During operation, there may be reception interference on the other side depending on the operating conditions or frequency relationship.

7. Other Functions

Shift and Split

This mode changes the transmit frequency in relation to the receive frequency.

- Shift** - appears on the display. The transmit frequency is the receive frequency minus the shift width (offset).
- + Shift** + appears on the display. The transmit frequency is the receive frequency plus the shift width (offset).
- Split** + - appears on the display. In VFO mode, if you are receiving on VFO-A, transmission takes place on the VFO-B receive frequency (however, the VFO-A settings for tone and DSQ etc., are used). When you are receiving on VFO-B, the opposite occurs. (In other words, the last displayed VFO is the receiving frequency.)

In memory and Call modes, transmission takes place on the frequencies programmed into each channel. When + - is displayed when programming a memory, the receive frequency of VFO-A or VFO-B, whichever is not displayed, is written to the memory as the transmit frequency.

1 Set the mode

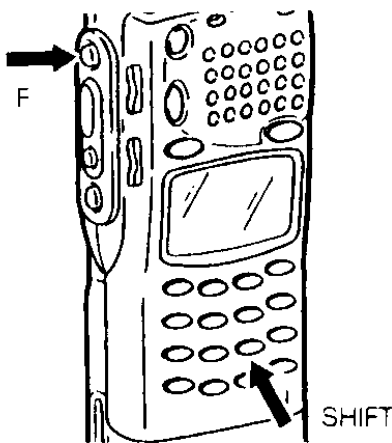

Hold down the **F** key and press the  key.
Each press of the key changes the main band setting.

- - Shift (- and the offset are displayed)
- ↓
- + Shift (+ and the offset are displayed)
- ↓
- Split (+ - and the receive frequency are displayed)
- ↓
- Cancel (the receive frequency is displayed)

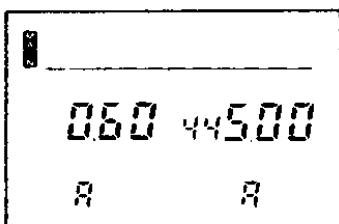



2 Changing the shift width

(operation when the offset is displayed during + or - shift)

- Offset range:
0 to 15.995 MHz
- Factory settings

	DJ-G5T	DJ-G5E
VHF	0.6MHz	0.6MHz
UHF	5.0MHz	7.6MHz

- ① Rotate the **DIAL**, or press the  or  key.
The offset will change up or down in tuning step units in the range shown on the left.
Holding the **F** key down to change the offset up or down in 1 MHz steps.
- ② Press **PTT**, the  key, or the main band's band key to return to the frequency display.

Off band

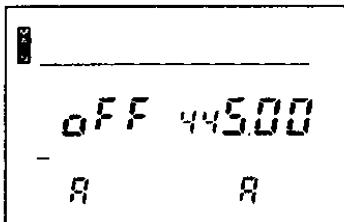



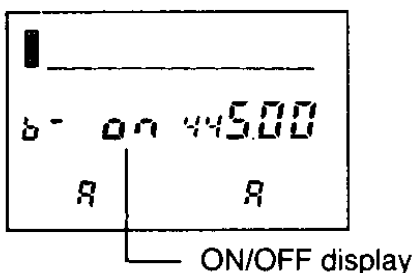
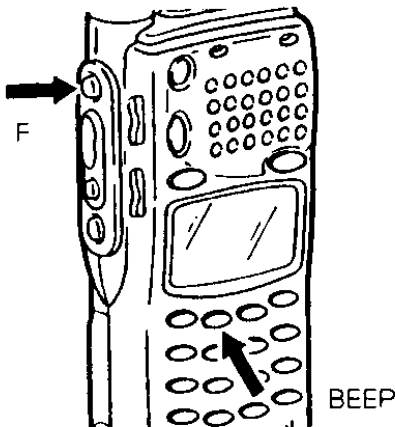

Press the **PTT** key to transmit when offset or split is set (for the transmission display will change). If the transmission frequency is outside the allowed transmission frequency range, **OFF** is displayed when you press **PTT**, and no transmission takes place.

Turning the Beep On and Off

The beep that sounds when keys are pressed can be turned off.





- ① Press the  key while holding down the **F** key.
- ② Rotate the **DIAL** or press the  or  keys to select the setting.
 - b - ON (Beep on)
 - ↓
 - b - OFF (Beep off)
- ③ Press **PTT**, , or the main band's band key.
The transceiver returns to the frequency display. The setting is common to both bands.

Turning the Bell Function On and Off

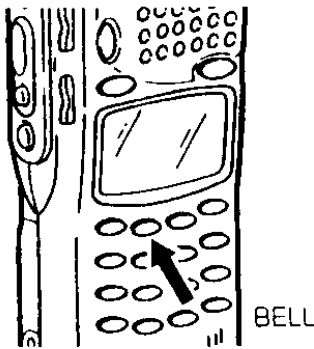

The bell function informs you that you are being called by outputting a bell sound, and displaying the  icon on the display.



Press the  key.

The  icon on the main band side appears. Press the  key again to cancel.

When a signal is received with the bell function on...

The  icon flashes and the transceiver alerts with a bell sound. Pressing the PTT key or  key when the  icon is flashing makes it disappear.

The bell sound is different for the L and R bands.

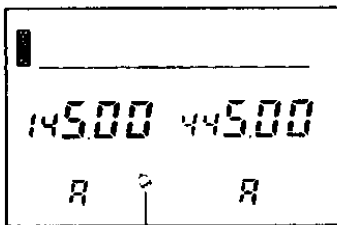

Bell icon display

Turning On the Display Light

1 Turning on the display light for five seconds

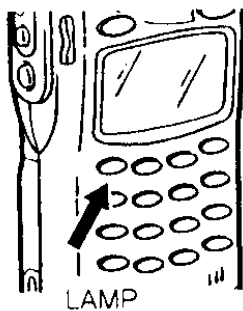

Press the  key.

The display lamp lights for five seconds, if any other key is pressed during this time, the lamp stays on for another five seconds. The lamp goes out five seconds after the last key operation.

To turn the lamp off, press the  key again.

2 Turning the lamp permanently on

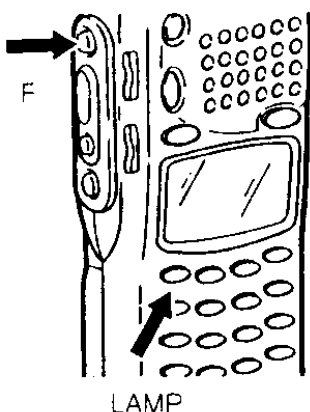

Press the  key while holding down the F key.

The lamp will stay on permanently. The lamp will come on automatically again if the power is turned off then on.

Press the  key to turn off the lamp and cancel the permanent lamp-on setting.

Switching the Attenuator On and Off

The attenuator reduces the reception sensitivity. When turned on, it reduces the reception sensitivity by about 15 dB. When your reception is being affected by strong side signals, the attenuator may improve reception.

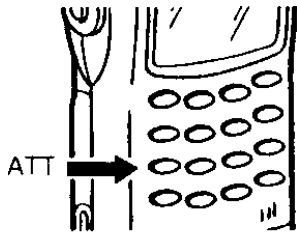

Press the **ATT** key.

The attenuator comes on, and **ATT** is displayed. The setting is common to both bands.

Press the **ATT** key again to cancel the attenuator.

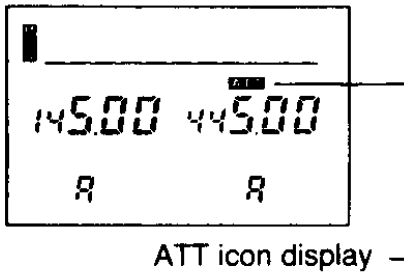

Setting the Tuning Step

The tuning step frequency is the basic frequency step unit used for setting the VFO frequency, and when scanning and using the Channel Scope. The factory settings are 5 kHz for the DJ-G5T, and 12.5 kHz for the DJ-G5E. It is possible to set the tuning step independently for VFO-A and VFO-B.

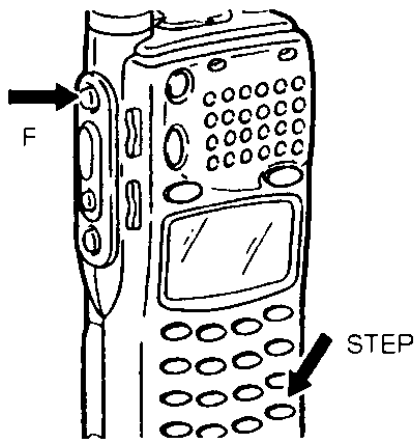

① In VFO mode, hold down the **F** key and press the **STEP** key.

② Rotate the **DIAL** or press **▲** or **▼** to select the step value.

5.0/10.0/12.5/15.0/20.0

25.0/30.0/50.0 (unit: kHz)

③ Press **PTT**, **ENT**, or the main band's band key.

The transceiver returns to the frequency display.

Note

Changing the step value from 5 K, 10 K, 15 K, 20 K, or 30 K, to one of 12.5 K, 25 K, or 50 K, or vice versa may cause the frequency and offset to compensate and adjust its last digit(s).

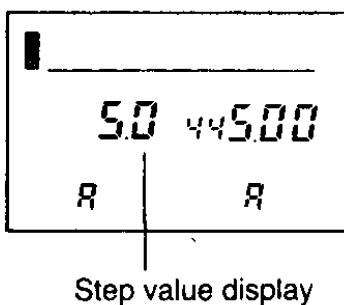

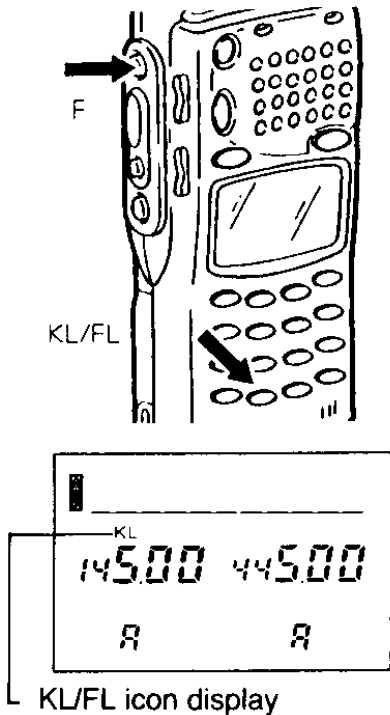

Keylock

The keylock function prevents you from accidentally changing settings by erroneous key operation.



Press the  key while holding down the **F** key.
The setting changes each time you press the key.



- **KL** (Keylock)
 - The **PTT**, **PTT2**, **MONI**, **VOL**, **SQ**, and  keys, and the **DIAL** work. All other keys are disabled.
- **FL** (frequency lock)
 - The **PTT**, **PTT2**, **MONI**, **VOL**, **SQ**, and  keys work. The **DIAL** and all other keys are disabled.
- Cancel

The settings are common to both bands.

Auto Power Off

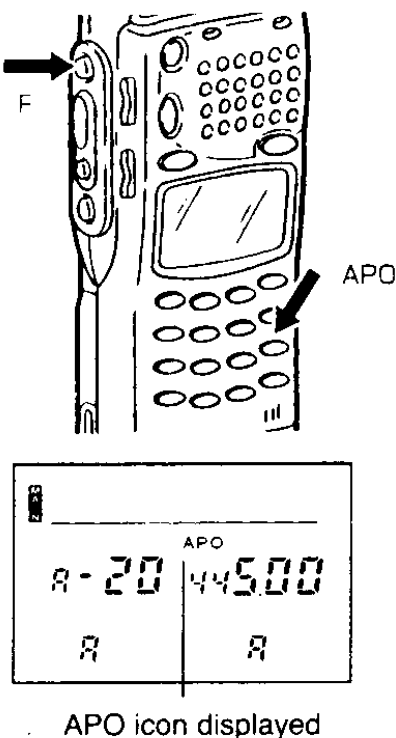
This function automatically turns off the power if there are no operations for a specified period of time.



- ① Hold down the **F** key and press the  key.
- ② Rotate the **DIAL** or use the  or  keys to select a setting.

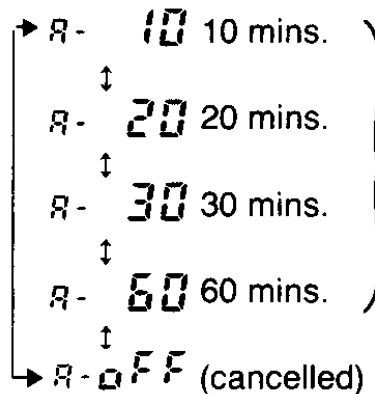

APO appears on the display. If no operations are performed within the specified time the transceiver turns off. 30 seconds before it turns off, the APO icon flashes, and the alarm sounds.

- ③ Press **PTT**, , or the main band's band key.
The transceiver returns to the frequency display. The setting is common to both bands.

Battery Save

The battery save function extends battery life by rapidly cycling the transceiver internal power on and off if there is no key operation or signal received for five seconds.

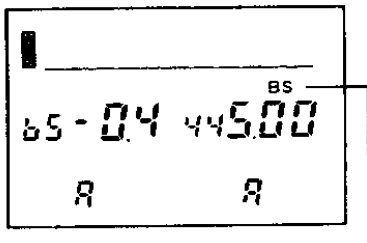
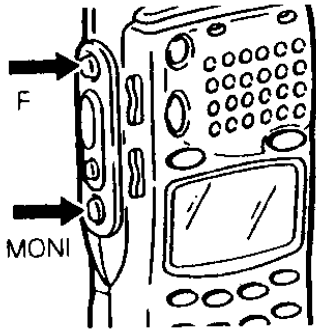

BS displayed

- ① Hold the F key down and press the **MONI** key.
- ② Rotate the **DIAL** or press or to make your selection.

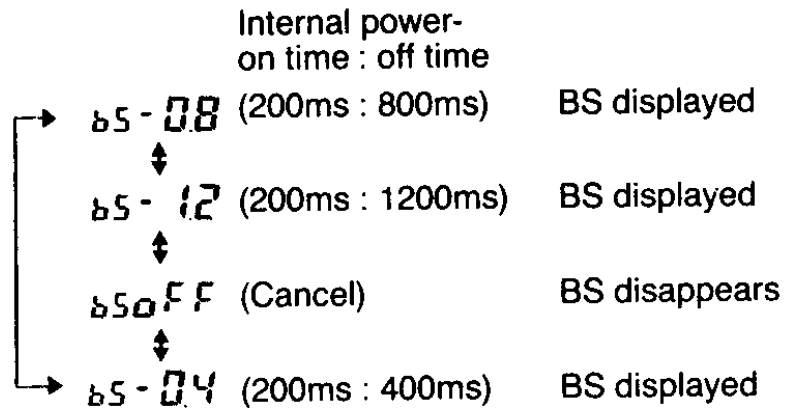

- ③ Press **PTT**, , or the main band's band key.
The transceiver returns to the frequency display. The setting is common to both bands.

Note

This function is canceled during the Channel Scope or scanning, but the BS icon remains in the display.

5

Sub Band Mute

Use this function to mute the sub band audio if it is annoying.

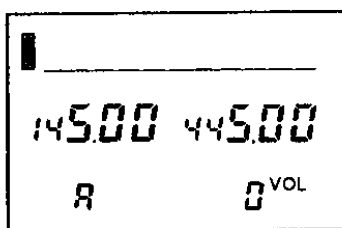
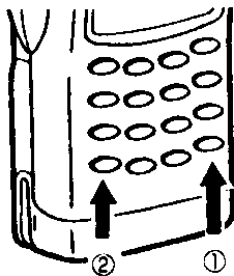

Mute display (volume 0)

- ① Press the key.
The frequency display is replaced by five dashes.
- ② Press the key.
The sub band audio goes off. As long as the sub band is muted, the sub band VOL icon appears and the level is displayed as 0. If you switch the main and sub bands with the sub band muted, the muted band also changes.

Repeat the above operation or adjust the sub band volume to unmute the sub band.

8. DJ-G5T Functions



The following functions are available only on the DJ-G5T.

Cross Band Repeater

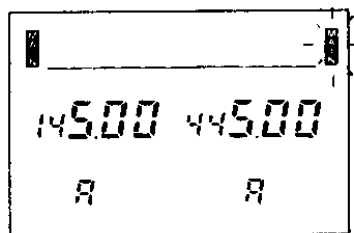
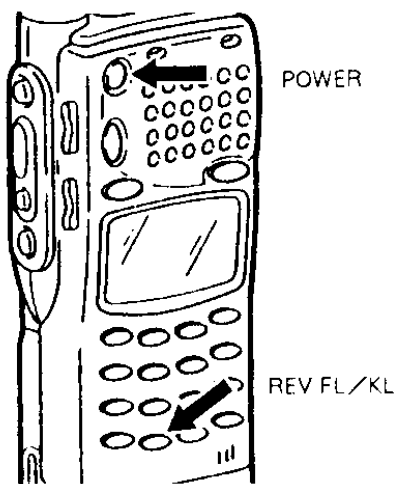
Transmits the received signal on the other band.



Hold down the  key and turn the power on.

The transceiver enters cross band repeater mode if the L band is a VHF frequency, and the R band is a UHF frequency. When the cross band repeater is operating,  flashes on the sub band side, and if a signal is received on either the L or R band sides, it is transmitted as is on the other side. When this happens, the transmitting side becomes the main band,  appears, and the lamp lights red. On the receive side,  flashes, and lamp lights green.

Perform the same key operation again to turn the cross band repeater off.

Note

Cross band repeater cannot be activated if split frequencies have been set.

No key operations are possible when the cross band repeater is operating.

AM Mode

The DJ-G5T normally receives FM, but it can also receive AM on the L band in VFO mode.

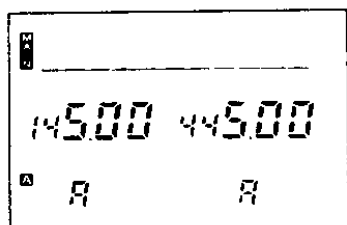
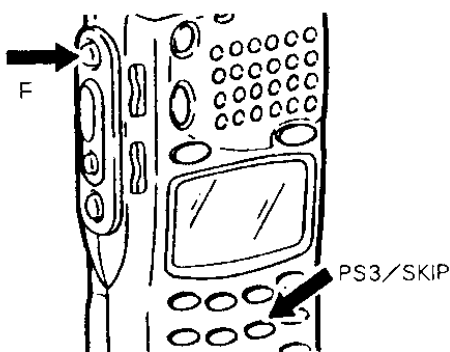

With the L band sets to the **MAIN** band, and the transceiver in VFO mode, press the  key while holding down the F key.

The  icon appears on the display, and the transceiver enters AM mode.

Perform the same key operation again to turn off AM mode.

Note

It is not possible to change to AM mode during memory mode or Call mode. Performing the operation described above in memory mode turns memory skip on and off (page 28). The Channel Scope must be OFF when toggling AM and FM.

6. Communicating with a Specific Partner

Tone Squelch (CTCSS)

When using tone squelch and waiting to receive a signal, the squelch is unmuted only when the transceiver receives the decoder tone that you have selected for your station. Tone squelch can be set on each band. (page 50)

Tone frequency list
(50 frequencies, units: Hz)

67.0	69.3	71.9	74.4	77.0	79.7	82.5	85.4	88.5
91.5	94.8	97.4	100.0	103.5	107.2	110.9	114.8	118.8
123.0	127.3	131.8	136.5	141.3	146.2	151.4	156.7	159.8
162.2	165.5	167.9	171.3	173.8	177.3	179.9	183.5	186.2
189.9	192.8	196.6	199.5	203.5	206.5	210.7	218.1	225.7
229.1	233.6	241.8	250.3	254.1				

DTMF squelch (DSQ)

This function unmutes the squelch by sending and receiving a DSQ code programmed into a special purpose memory (group code, your station's code, your partner's station code). The DSQ code is added to transmitted signals, and only stations that have a code that matches this unmute their squelch. DSQ only operates on the main band side (page 51).

- Code squelch

Select a three-digit code and wait to receive. The transceiver's squelch only unmutes when it receives the same code. This can be used in the same way as tone squelch.

- Group pager

This is used to call all stations with the same group code. Your own station's code is transmitted with the group code, and is displayed on the receiving station side. This enables the receiving side to determine which group the call was from.

- Private pager

Sends the receiving station's code to call a particular station.

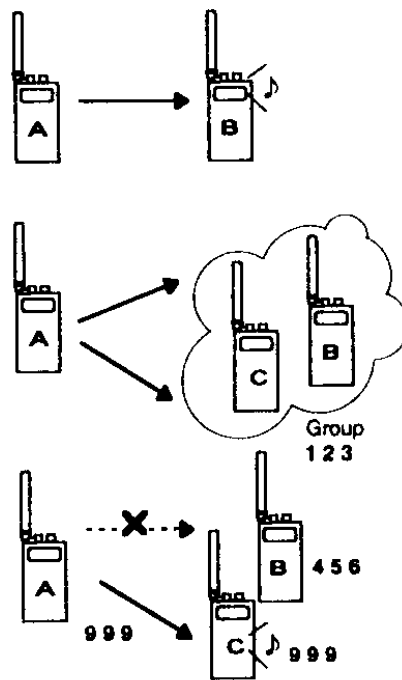

There are three types of DSQ code, all of which consist of three numerical digits. DSQ codes can be independently set for both the L and R bands.

Code type	Memory name	Description
Group code	1 to 8	Up to eight codes, for each group, can be set. Use to communicate in group pager mode, and code squelch.
Your station code	P	Private code for your station. Your station's private code. Required for receiving private calls on your station.
Partner station code	y	Code for making a private call to another station. When you receive a group or private pager call, the received partner station code is written here.

1. Tone Squelch

Tone Encoder and Tone Squelch

1 Adjust the squelch (page 11)

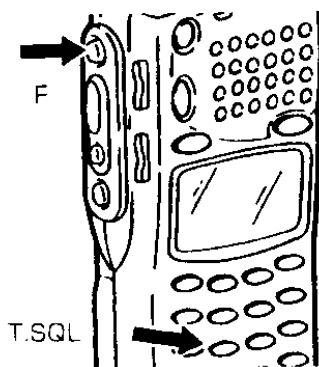

2 Set the tone mode



Press the  key while holding down the F key.
Each press of the key changes the main band setting.

→ Tone encoder	(T and the encoder frequency are displayed)
↓	
→ Tone squelch	(T.SQ and the decoder frequency are displayed)
↓	
→ Cancel	(display disappears)

3 Select the encoder and decoder frequencies

- ① Rotate the **DIAL** or press the  or  keys to select the tone frequencies. Select from the list of 50 frequencies on page 49. If you change the encoder frequency, the decoder frequency changes to the same frequency, but changing the decoder frequency does not change the encoder frequency.
 - ② Press **PTT**, the  key, or the main band's band key. The transceiver returns to the frequency display.
-

4 Transmit

If you transmit while **T** or **T.SQ** are displayed, the encoder tone is superimposed to the transmission.

5 Receive

If **T.SQ** is displayed, the squelch is unmuted and the received signal is audible only when a signal matching the decoder frequency is received.

Note

When tone squelches on L and R bands are unmuted together by each respective matching tone, one squelch may stay unmuted even if the tone changes or discontinues on the received signal, until the signal disappears.

2. DSQ

Setting DSQ Mode and Codes

1 Adjust the squelch (page 11) Turn off the Channel Scope.

2 Set the DSQ mode

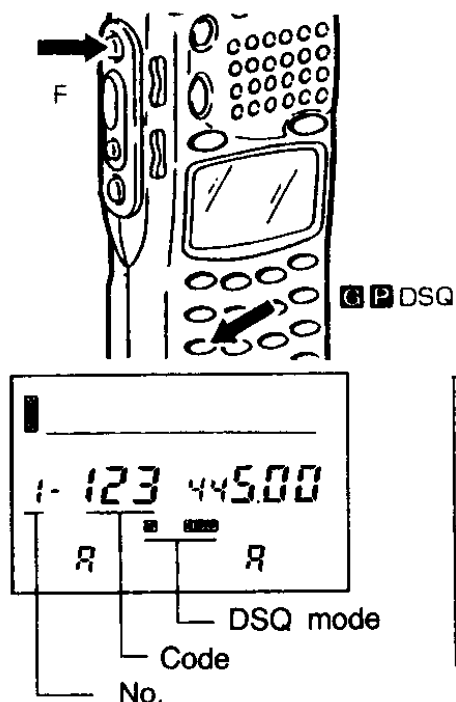

DSQ only operates on the main band. The sub band DSQ setting is not displayed, and the DSQ setting display always refers to the main band side.

Press the key while holding down the F key.

Each press of the key changes the main band setting.

Refer to pages 52 and 53 regarding use of the functions for each mode.

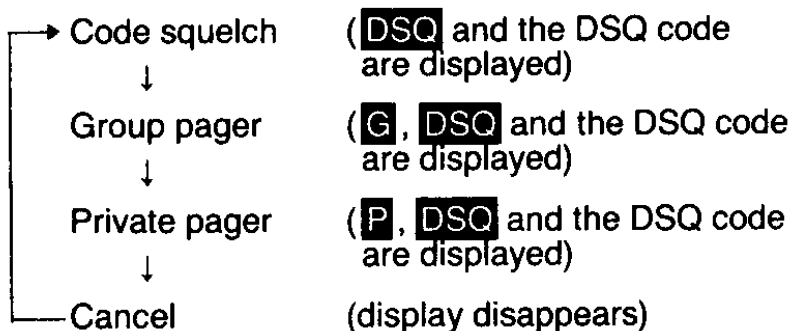

3 Select the DSQ code

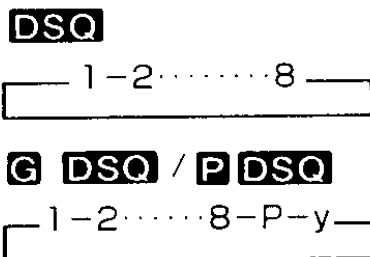

Rotate the **DIAL** or press the or keys while the code is displayed.

The displayed code changes as shown on the left. When entering the DSQ code, select the relevant code and enter it. (Refer to “4 Enter a DSQ code.” on the following page.)

- When **DSQ** is displayed, select the transmit/receive code from group 1 to 8.
- When **G DSQ** is displayed, select the number of the group that you wish to call from group 1 to 8.
- When **P DSQ** is displayed, you do not need to select a code.
- The DSQ code number can be selected independently for VFO-A and VFO-B. Also, when programming the memories, the separate numbers are written to the memory channel and Call channel.

4 Enter a DSQ code

DSQ codes can be set separately for the L band and R band.

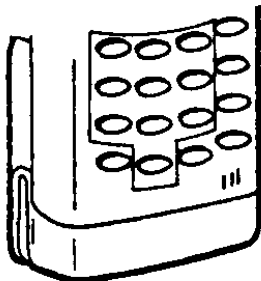

Enter three digits from the range 0 to 9 from the keyboard.

When you enter the third digit, you are returned to the first digit. To program multiple DSQ codes in sequence, go to step 2 and enter the next code. To clear a code that you have entered, hold down the F key and press the 0 key.

5 Finish the setting

Press the PTT, ^{ENT}0, or main band's band key.

The transceiver will return to the frequency display.

Group code monitor

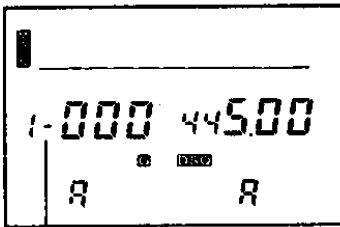

Group code monitor indicator

Before a code is entered, there is a blank between the group code No. and the three-digit code. When you enter a code, a dash (“—”) is displayed. This indicates that the code can receive group pager calls.

Codes that do not have a dash displayed will not receive calls even if the codes match.

Turning the group code monitor on and off.

Hold down the F key and press the 0 key.

This toggles the dash display on and off.

It is possible to turn the monitor on for programmed groups in the range 1 to 8 that you wish to accept calls, and off for the others.

Note

- Turning the monitor on and off has no effect for code squelch (DSQ).
- There is no on/off for the P and y codes (the dash is always displayed).

Communicating Using Code Squelch Mode (DSQ)

Select one of the group codes (from 1 to 8) and transmit. When receiving, the squelch only unmutes when the code of the received signal matches the selected code.

1 Prepare

Enter code squelch mode (DSQ), and enter and select the transmit/receive code (page 51).

2 Transmit

Press PTT, and the most recently displayed code (three digits) is transmitted.

3 Receiving

When a three-digit code that matches the selected main band three-digit code is received, the squelch unmutes and audio is output.

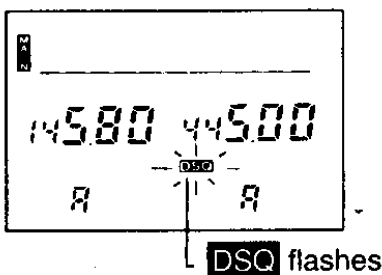

The alarm sounds and DSQ flashes.

- Press the key or the main band's band key and DSQ will stop flashing.
- Press PTT to send the three-digit code to the transmitting station and return to the original display.

Communicating Using Group Pager Mode (G DSQ)

The transmitting side sends the group code and its own station code (totalling seven digits). The receiving side unmutes its squelch if one of its programmed group codes matches the received group code.

1 Prepare

Enter group pager mode (G DSQ) and enter or select the transmission code (page 51).

2 Transmit

Press PTT. The transceiver sends the seven-digit code shown on the right, and outputs DTMF.



Group
code

Sending
station's code

Note

If the most recently displayed code was P or y, group 1 is automatically selected.

3 Receive

In the main band, If a **[*]** is received after a code that matches one of the programmed group codes (1 to 8) that has the group monitor turned on (“—” displayed), the squelch unmutes and audio is output.

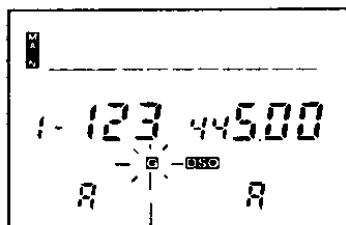

An alarm sounds, **[G]** flashes on the display, and the matching group code is displayed.

- Press the **[E]** key or the main band’s band key and **[G]** will stop flashing.
- Press **PTT** to send the seven-digit code to the transmitting station and return to the original display.

Note When the received code matches the receiving station’s code, the transceiver switches to private pager mode, even if there is a matching group code.

Communicating Using Private Pager Mode (**[P DSQ]**)

The transmitting station sends a receiving station’s code, and its own code. If the receiving station receives a code that matches its code, it unmutes its squelch.

1 Prepare

Enter private pager mode (**[P DSQ]**), and enter your station code and the receiving station code (page 51).

2 Transmit

Press **PTT**. The transceiver sends the seven-digit code shown on the right, and outputs audible DTMF.

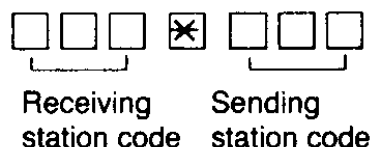

3 Receive

In the main band, If a **[*]** is received after a code that matches the receiving station code, the squelch unmutes and audio is output.

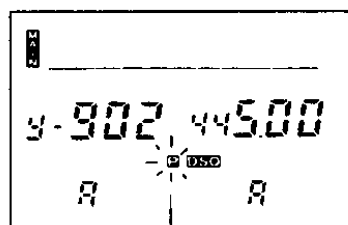

An alarm sounds, **[P]** flashes on the display, and the transmitting station’s code is displayed.

- Press the **[E]** key or the main band’s band key and **[P]** will stop flashing.
- Press **PTT** to send the seven-digit code to answer to the transmitting station and return to the original display.

Note If the received code does not match the receiving station’s code, but matches one of its group codes (1 to 8), the transceiver switches to group pager mode.

Setting the DTMF Transmission Delay Time

Normally DSQ codes are sent 450 ms after the PTT key is pressed, but this can be changed to 750 ms.

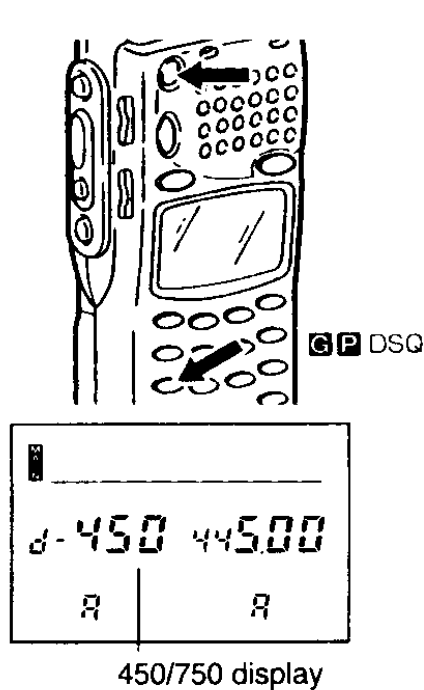

- ① Hold down the **ATTEN** key and turn the power on. The current main band setting is displayed.
- ② Rotate the **DIAL** or press the **▲** or **▼** keys to change the setting.

When communicating through a repeater, set the delay time to 750 ms so that the DSQ code is transmitted after the repeater establishes the connection.

- ③ Press the **PTT**, **ENT**, or main band's band key. The transceiver will return to the frequency display. This setting is common to both bands.

Outputting DTMF Codes Manually

Hold down the PTT key, and press the keyboard keys to send DTMF codes of the keyboard keys.

Notes regarding DTMF operation

- If, after receiving the three-digit code followed by ***** when **G DSQ** or **P DSQ** are displayed, the sending station's code is not received, the squelch will unmute, and an error (E) is displayed.

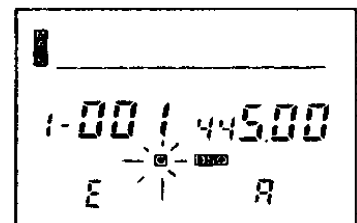

- If the codes match and the squelch unmutes, and the signal is interrupted, communication is possible for 1.5 seconds. If there is no signal during this time, the squelch mutes again.

- The transceiver has difficulty receiving DSQ codes when the battery save function is on. We recommend that you turn battery save off when waiting to receive a DSQ code.



- The DSQ setting is invalid during scanning, Channel Scope, sweep scanning, and priority watch.

3. Auto Dialer

This function automatically sends pre-programmed DTMF codes. The DJ-G5T/E has a total of 20 Auto Dialer memories (common to both the L and R bands). Note, however, when the number of memory channels is set to 100, there is only one Auto Dialer memory.

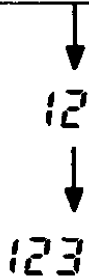
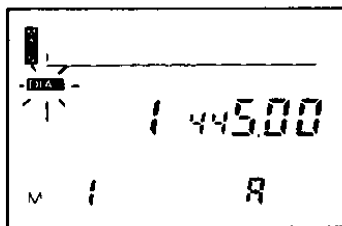
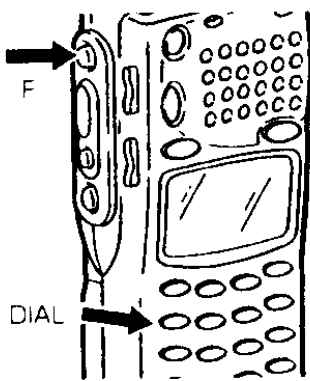
Programming Dial Codes



- ① Hold down the F key and press the  key. **DIAL** flashes in the display, and the auto dialer memory No. and code appear on the main band side (the code is blank when shipped from the factory).
- ② Rotate the **DIAL** and select a memory.
- ③ Enter a code using any one of the 16 keyboard keys. The code is displayed on the right edge of the display. The code entered before this one shifts to the left. A maximum of 15 digits can be entered. The  key is displayed as **H**, and the  key as **B**.
- ④ Press **PTT** or the main band's band key. The transceiver returns to the frequency display. **DIAL** appears on the display. (**DIAL** does not appear if numbers have not been entered to that autodial memory.)

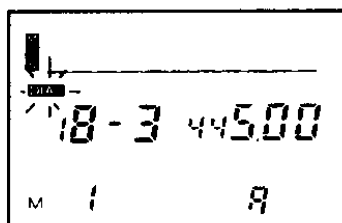

Entering a pause

Entering a pause puts a one second gap between transmission of codes.



Hold down the F key and press the  key. "—" appears, and a one second gap is put between the codes before and after this. Up to 15 characters, including the pause can be entered.

Modifying Programmed Auto-Dial Codes

- ① Select the memory No. in the dial code programming mode.
- ② Hold down the F key and rotate the dial or press the  or  keys. Move to the right end of the code before the one that you wish to modify.

Example: When 123 # 354 has been entered

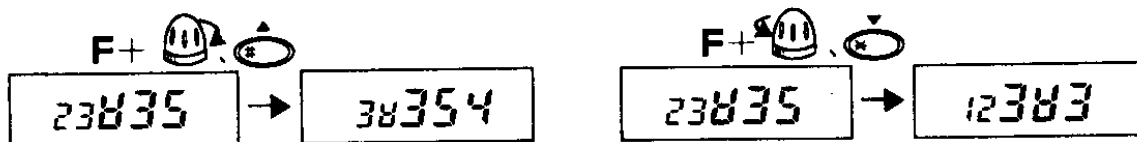

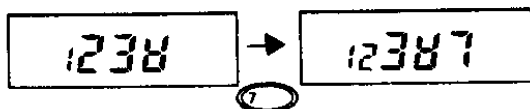

- ③ Enter the new code.

Example: Modify 123 # 354 to 123 # 754

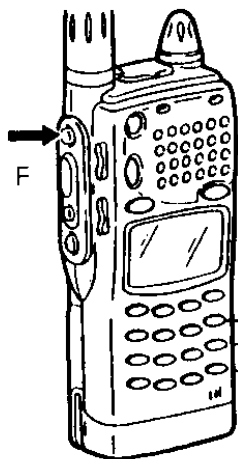

- ④ Erasing a code.



Hold down the F key and press the  key. The character on the right edge of the display is erased (backspace).

Hold down the F key and press the  key. The displayed memory's code is erased (clear all).

Hold down the F key and press the  key. The character after the character at right edge of the display is erased (delete).

Sending Codes Using the Auto Dialer

- ① Select the dial memory that you wish to send and exit the setting mode.
Confirm that **DIAL** is displayed.
- ② While pressing either **PTT** or **PTT2**, press the F key.
The selected code is sent.

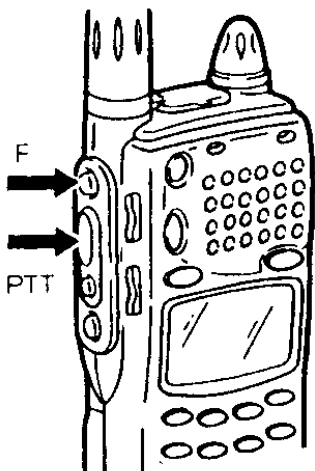

7. Maintenance and Reference

● Troubleshooting

The items listed in the table below are not problems with the transceiver. Please check the list before concluding that the transceiver is faulty. If the problem persists, reset the transceiver (page 60), this can sometimes correct erroneous operation.

Symptom	Cause	Action
Nothing appears on the display when you turn the power on.	a. Poor NiCad battery pack connection. b. Dead battery. c. You are releasing the key too quickly.	a. Check that the battery pack terminals are clean. b. Recharge the battery. c. Hold the power switch down longer.
No speaker audio. Cannot receive.	a. Volume too low. b. Squelch level too high. c. Tone squelch is operating. d. DSQ is operating. e. Sub mute is operating. f. You are pressing the PTT key to transmit.	a. Adjust the volume. b. Adjust the squelch. c. Turn off tone squelch. d. Turn off DSQ. e. Turn off sub-mute. f. Release PTT.
Poor receiving sensitivity.	Attenuator is operating.	Turn off the attenuator.
Frequency display is incorrect.	CPU error.	Reset.
Won't scan.	Squelch is unmuted.	Set the squelch so that noise is just muted.
Cannot do programmed scan.	Programmed scan edges are not set correctly in memory.	Program the upper and lower scan edges correctly.
Frequency and memory No. do not change.	a. Keylock is set. b. Transceiver is in Call mode.	a. Turn off keylock. b. Go to VFO mode.
Key entry not possible.	a. Keylock is set. b. Channel Scope is ON. Some entries are not accepted during the Channel Scope.	a. Turn off keylock. b. Turn off the Channel Scope.
Repeater cannot be used.	Incorrect setting for repeater use.	Set the transceiver correctly for repeater use.

Symptom	Cause	Action
Cannot transmit. Display flashes or goes out when you transmit.	Battery is flat.	Recharge.
Cannot transmit. No reply when you transmit.	<ul style="list-style-type: none"> a. Not pressing PTT firmly enough. b. You are off band (when shift and split are set). c. Incorrect frequency. 	<ul style="list-style-type: none"> a. Press PTT and confirm that the ON AIR lamp lights red. b. Transmit within the transmission frequency range. c. Match your frequency to the receiving station frequency.
Cannot receive calls with DSQ.	<ul style="list-style-type: none"> a. Signal is weak. b. Other party's DTMF level is improper. c. Channel Scope is ON. 	<ul style="list-style-type: none"> a. Receive good strength signal. b. Other party to adjust the DTMF encode level. c. Turn off the Channel Scope.

● Resetting

The DJ-G5T/E has two types of reset. When you reset the transceiver, the settings are returned to the initial factory settings.

1 Full reset (all settings initialized)

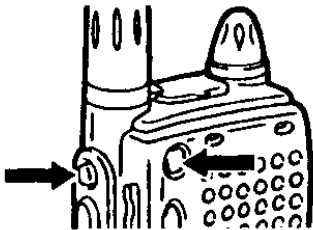

Hold down the **F** key and turn the power on.

While the **F** key is held down, every segment on the LCD display will appear. When you release the **F** key, the normal frequency display will appear (VFO-A initial setting).

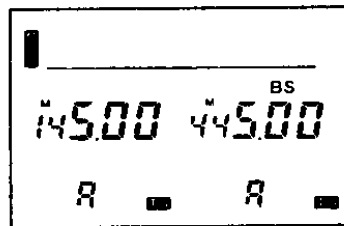
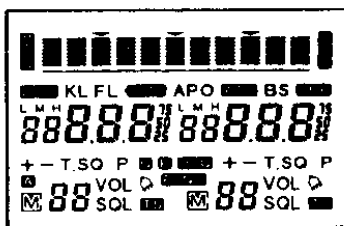

(for the DJ-G5T)

2 VFO reset (VFO-A and VFO-B settings initialized)

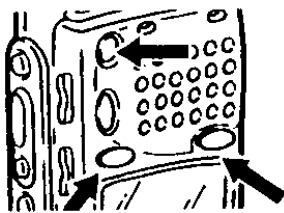

Hold down a band key (**L** or **R**), and turn the power on.

The VFO-A and VFO-B settings for both the **L** and **R** bands are initialized. The memory channels, DSQ codes, and auto dialer memories are not affected.

Factory settings		DJ-G5T	DJ-G5E
VFO frequency Call frequency Programmed scan edges	L band	145.000MHz	145.000MHz
	R band	445.000MHz	433.000MHz
Offset	VHF	0.6MHz	0.6MHz
	UHF	5.0MHz	7.6MHz
Tuning step		5kHz	12.5kHz
PTT2 key setting		Low power transmit	Tone burst
Main band	L band	Scan resume conditions	Timer scan
Operating mode	VFO-A	Transmit power	M
Shift, split, tone, and DSQ mode settings	None (off)	No. memory channels	80 CH
Tone frequency	88.5Hz	Keylock, Bell, APO, Full duplex, Attenuator, and DIAL settings	Off
Volume level (VOL)	5	Battery save	On (800 ms)
Squelch level (SQL)	3		
Memories (1 to 80)	Blank		

● Packet Operation

Packet operation is used for communicating data (from a computer etc.) rather than voice.

For packet operation, connect the DJ-G5T/E as shown in the diagram below. Connect the packet communication TNC (Terminal Node Controller accessory) terminals to the SP ($\phi 3.5$ mm plug) and MIC ($\phi 2.5$ mm plug) connectors on top of the transceiver.

- Input level adjustment The transceiver has no MIC level adjustment circuit. Adjust the level at the TNC side.
- Output level adjustment Use the VOL $\blacktriangle/\blacktriangledown$ key on the side of the transceiver to adjust the output level from the SP2 terminal.

Packet operation connections

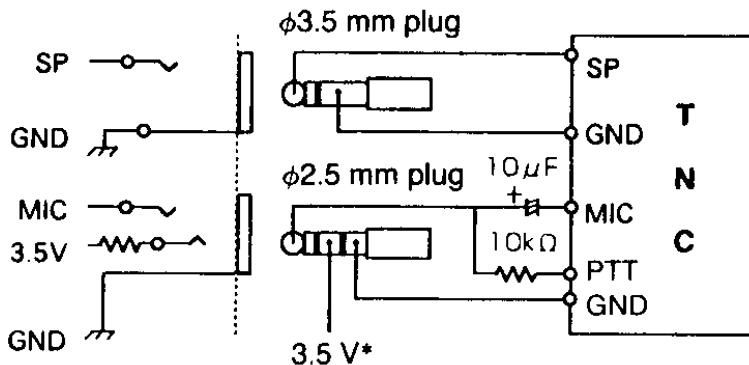

*Power is supplied from the internal 3.5 V line through a 100 Ω resistor.

Note

- Refer to the TNC's instruction manual regarding connection of the TNC unit to other devices (personal computers etc.). If the transceiver, TNC unit and connected personal computer are too close together, noise between the transceiver, TNC and personal computer will cause interference.
- Turn the battery save function off during packet operation (page 41).
- Confirm your frequency and your communicating partner's frequency. If the frequencies are off, the number of retries will be large.
- Turn down the sub band volume during packet operation.

● Cloning Over the Air

VFO frequencies, memory information and other set data can be easily transferred to another DJ-G5T/E producing copy (or clone) of the information programmed into a transceiver (no cable is necessary). This is convenient for programming a group of transceivers with the same information.

Caution

- Cloning is possible only between DJ-G5T's, or between DJ-G5E's (not between DJ-G5T and DJ-G5E).
- Do not use the cloning function through a repeater.
- When in cloning mode the transmitter output is automatically changed to Low.

- ① Set the sending (master) and receiving (slave) transceivers to the same frequency.
- ② Turn power OFF on both transceivers, then, while pushing  turn power back ON.

Both transceivers are now in clone mode.

(**CLONE** displayed on both.)

- ③ Press **PTT** on the master transceiver.

The master transceiver starts sending data and the slave transceiver starts to receive. The slave transceiver displays "**LOAD**", but the S-meter will not show, busy lamp (green) remains unlit, and no sound from the slave side will be heard (the entire process takes about 10 min.).

When cloning is complete the master transceiver and the slave transceiver enters cloning mode, thus displaying **CLONE**.

- ④ Push **PTT** on the sending side (master) transceiver to transfer data again; turn power OFF then ON again to return to normal operating mode.

Note Receiving side (slave) error

Pushing **PTT**, turning power OFF on the slave transceiver or any noise during cloning results in a cloning error.

When a cloning error occurs, the receiving side (slave) transceiver displays "**ERR**" and cloning must be started from the beginning again.



● Options

The following options are available for the DJ-G5T/E.

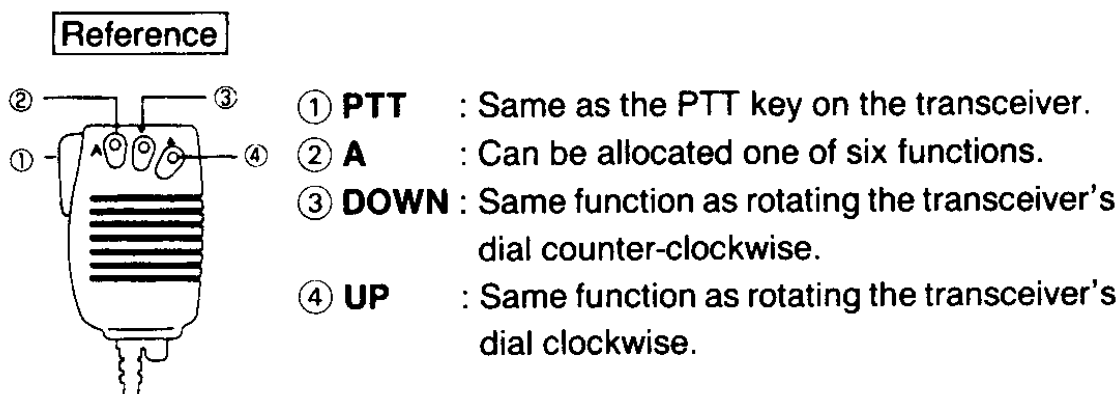
EMS-8 Remote control speaker microphone



A key function allocation

- ① Press the A key on the MIC while pressing the F key on the transceiver.
- ② Use the transceiver's **DIAL**, or the  or  keys to allocate one of the following functions to the A key.

0 : Main band switch	3 : Twin/Mono band switch
1 : VFO/memory switch	4 : VFO-A/B switch
2 : MONI key	5 : VFO band switch
- ③ Press PTT, the transceiver's band key, or the MIC's A key to return to the frequency display. A will now operate according to the function allocated to it.

EBP-33N	Rechargeable Ni-Cd Battery 4.8VDC 650mAH
EBP-34N	Rechargeable Ni-Cd Battery 4.8VDC 1200mAH
EBP-35N	Rechargeable Ni-Cd Battery 7.2VDC 900mAH
EBP-36N	Rechargeable Ni-Cd Battery 9.6VDC 650mAH
EBP-37N	Rechargeable Ni-Cd Battery (Low cost type) 4.8VDC 700mAH
EDH-16	Drycell Battery case AA × 4 pcs.
EDC-63	Trickle charger 120VAC input
EDC-64	Trickle charger 220VAC input
EDC-60	Rapid charger 120VAC input
EDC-61	Rapid charger 220VAC input
EDC-36	Car-lighter cable with filter
EDC-37	Cable for external power source
ESC-28	Soft-case for use with EBP-33N
ESC-29	Soft-case for use with EBP-37N
ESC-30	Soft-case for use with EBP-34N/35N/36N

● Charger EDC-63 (for 120VAC), EDC-64 (for 220VAC)

This unit is a Charger for exclusive use of Ni-Cd Battery Packs used with ALINCO handheld transceiver.

With EDC-63/EDC-64, the battery packs EBP-33N/EBP-34N/EBP-35N/EBP-36N/EBP-37N can be charged while it is attached to the transceiver or the receiver.

< Installation >

Insert the battery-pack fully into the charger unit, matching the grooves. The red lamp will light up and charging will start.

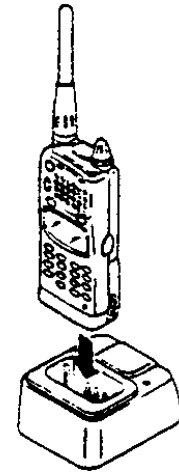

EDC-63/64

EBP-33N
EBP-34N
EBP-35N
EBP-36N
EBP-37N

Caution

1. Turn off the transceiver power while charging.
2. Never charge the battery packs of other makes with this Charger.
3. The required charging time depends on the conditions and the models of battery pack. Refer to the instruction manuals of the battery pack.
4. Never short-circuit the charging terminals of this Charger with a metal object, etc. for the charger may be damaged by a strong current.
5. Precaution
Don't insert the above mentioned Ni-Cd batteries viceversa.
This mis-use causes damage on the drop in charger.
6. Never mount the battery pack in the charger backwards.
7. Charging should be conducted in the temperature range of 0°C to 40°C as incomplete charging or deterioration of battery performance may occur if charged outside this range.

● Ni-Cd Battery EBP-33N/34N/35N/36N/37N

Note

1. The battery pack is not charged when shipped. It must be charged before using.
2. Charging should be conducted in the temperature range of 0°C to 40°C, as incomplete charging or deterioration of battery performance may occur if charged outside this range.
3. Do not modify, dismantle, incinerate or immerse the battery pack in water as this may be dangerous. Be careful not to drop the battery pack or subject it to any severe shocks.

4. Never short-circuit the battery pack terminals, as this may cause damage to the equipment or lead to heating of the battery which may cause burns.
5. Unnecessarily prolonged charging (overcharging) may result in deterioration of battery performance.
6. The battery pack should be stored in a dry place with a temperature range of -20°C to $+45^{\circ}\text{C}$. Temperatures outside this range or extremely high levels of humidity may lead to leaking of the battery liquid or resting of the metal components of the batteries.
7. Normally the battery pack can be charged up to 300 times. However, the battery pack can be considered to be exhausted if the period of use drops off markedly despite being charged for the aforementioned time. When this happens, a new pack should be used.
8.  **ATTENTION:** The battery that you have purchased is recyclable. At the end of its useful life, under various state and local laws, it may be illegal to dispose of this battery into the municipal waste stream. Check with your local solid waste officials for details in your area for recycling options or proper disposal.
Ni-Cd

Charging with EDC-63 or EDC-64 (Normal Charger)

1. Mount the Ni-Cd battery pack in the charger. The red lamp will light up and charging will start.
2. See table 2 for charging time. Dismount the battery pack from the charger after the charging.

Charging with EDC-60 or EDC-61 (Quick Charger)

1. Mount the Ni-Cd battery pack in the charger. The red lamp will light up and charging will start.
2. When the battery pack is mounted correctly, the red lamp will light up and quick charging will start.

When quick charging is completed, the red lamp will go off/the green lamp will light up. The charge rate will be then reduced to a weak supplementary charge rate to protect the battery pack from overcharging.

Specifications

	BATTERY CAPACITY	OUTPUT VOLTAGE
EBP-33N	650mAH	4.8V
EBP-34N	1200mAH	4.8V
EBP-35N	900mAH	7.2V
EBP-36N	650mAH	9.6V
EBP-37N	700mAH	4.8V

Charging Times and Chargers

	EDC-63 (for 120V) EDC-64 (for 220V)	EDC-60 (for 120V) EDC-61 (for 220V)
EBP-33N	Approx. 10 hours	Approx. 0.7 hour
EBP-34N	Approx. 18 hours	Approx. 1.2 hours
EBP-35N	Approx. 10 hours	Approx. 1.7 hours
EBP-36N	Approx. 10 hours	Approx. 1.2 hours
EBP-37N	Approx. 11 hours	Approx. 0.7 hour

The above times are required for completely discharged battery pack.

ATTENTION !

PREVENT SHORT-CIRCUITING OF THE Ni-Cd BATTERY PACK

Be extra cautious when carrying the Ni-Cd battery pack; short-circuiting will produce surge current flow resulting in possible fire.

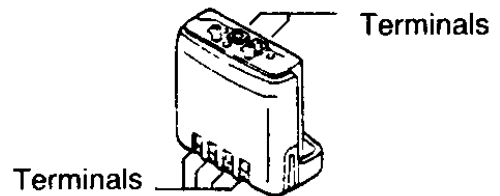

<p>DON'T carry with metals of any type, e.g. chains.</p>	<p>DON'T carry the Ni-Cd battery pack inside bags of metal plated interior.</p>	<p>DON'T place in the proximity of metals or conductives, e.g. nails, chains.</p>
<p>DO enclose inside a non-conductive enclosure (bags or handkerchief made only of non-conductive material).</p>	<p>DO protect by spreading a non-conductive sheet to place on a flat surface.</p>	

*For Carrying The battery pack, it should be kept in the bag provided.

ALINCO, INC.

Head office: "TWIN 21" MID Tower Building 25F
1-61, 2-Chome, Shiromi, Chuo-ku, Osaka 540-8580 Japan
Phone: 06-6946-8150 Fax: 06-6946-8175
E-mail: export@alinco.co.jp
U.S.A.: 438 Amapola Ave., Suite 130, Torrance, CA 90501-6201 U.S.A.
Phone: 310-618-8616 Fax: 310-618-8758
<http://www.alinco.com/>
Germany: Eschborner Landstrasse 55, 60489 Frankfurt am Main, Germany
Phone: 069-786018 Fax: 069-789-60766